

www.Dentcraft.com • 1-888-738-6657 • email: info@dentcraft.com

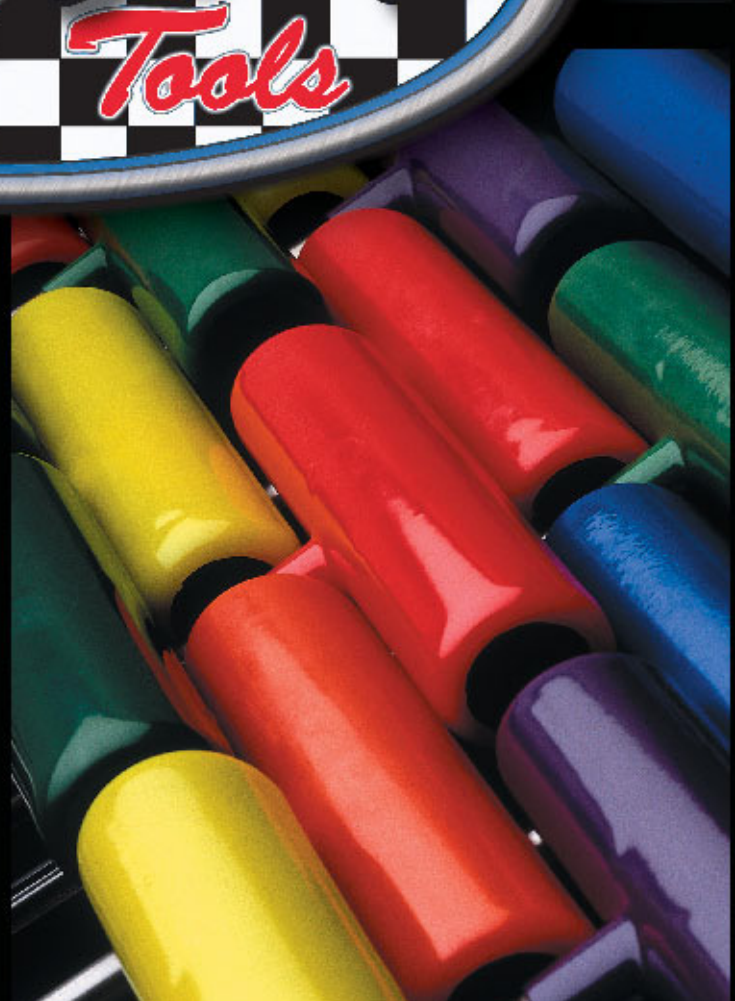

Professional Paintless Dent Repair Tools • Vol. 10



*Paintless Dent
Repair is the next
best thing to it
never happening!*

Dentcraft Tools was established in 1997 by founder and PDR Technician, Sid Emmert. Before Sid started manufacturing tools, he met with professional metallurgists to choose the appropriate steel for each particular tool. Dentcraft Tools uses several different high carbon steels in each set. In quality control testing, our material far exceeds stainless steel tools in strength and durability. To the serious PDR professional, Dentcraft Tools' strength and design will meet or exceed your expectations. Produced with color-coded handles, you can be sure to grab the right tool to get the job done.

*PDR does more
to restore and*

We introduced the Company Set in 1997. Since then, we have improved the original Company Set with no additional price increase. To this day, the Company Set is still \$1,995. Since the introduction of the Company Set, Dentcraft Tools has produced and manufactured many more additional tools. With feedback from our customers, we will continue to grow and develop the best tools in the industry to keep up with the ever-evolving PDR trade.

*preserve the
value of an
automobile than
any other
alternative.*

In 2018, we introduced the Pro Set. Although you can still purchase the original Company Set, the Pro Set is more of an updated version with a cost of \$2,150. This set includes many of the same tools in the Company Set, as well as some of our other best selling tools.

At the time of purchase of the Company Set or Pro Set, your set can be expanded with any tool we manufacture at a discounted rate of 35% off the individual tool price. In other words, when you purchase the Company Set or Pro Set, you can purchase one (per Company Set or Pro Set purchased) of each tool we manufacture (not in the set) to expand your set at a 35% discount. This allows you to expand your set to suit your needs, at the same great value.

Dentcraft Tools

How To Order

Dentcraft Tools, L.P.
8118 Glade Avenue
Oklahoma City, OK 73132

Or Call Toll-Free: 1-888-738-6657
OKC: (405) 495-0533

Business Hours
Mon - Thurs 8am-5pm • Fri 8am-3pm CT
or online 24 hours a day at:

www.Dentcraft.com
email: info@dentcraft.com

Orders placed before Noon CT will be shipped the same day.
Orders placed after Noon CT will be shipped the following day.



Discover, Visa, MasterCard, American Express accepted, or method of payment may be a money order or cashier's check for C.O.D. orders. Shipping charges, C.O.D. (**\$17.50 per box**) and any applicable taxes will be added to all orders.

Check our website for latest updates!

100% Money Back Guarantee!

Try them for 60 days.
If you are not 100% satisfied with any tool,
just return it for a full refund.

Lifetime Warranty

Dentcraft Tools, L.P. provides a lifetime guarantee against breakage on any Dentcraft tool we make 3/16" diameter or larger. We provide a three-year guarantee on our Collapsible Rod Set and a one-year guarantee on whale tails and tools smaller than 3/16" diameter. Any tools returned for any other reason must be returned within 60 days of purchase to receive a full refund.

www.Dentcraft.com • 1-888-738-6657 • email: info@dentcraft.com

2

PRO SET 63 Pieces \$2,150

35% Discount Off Individual Prices

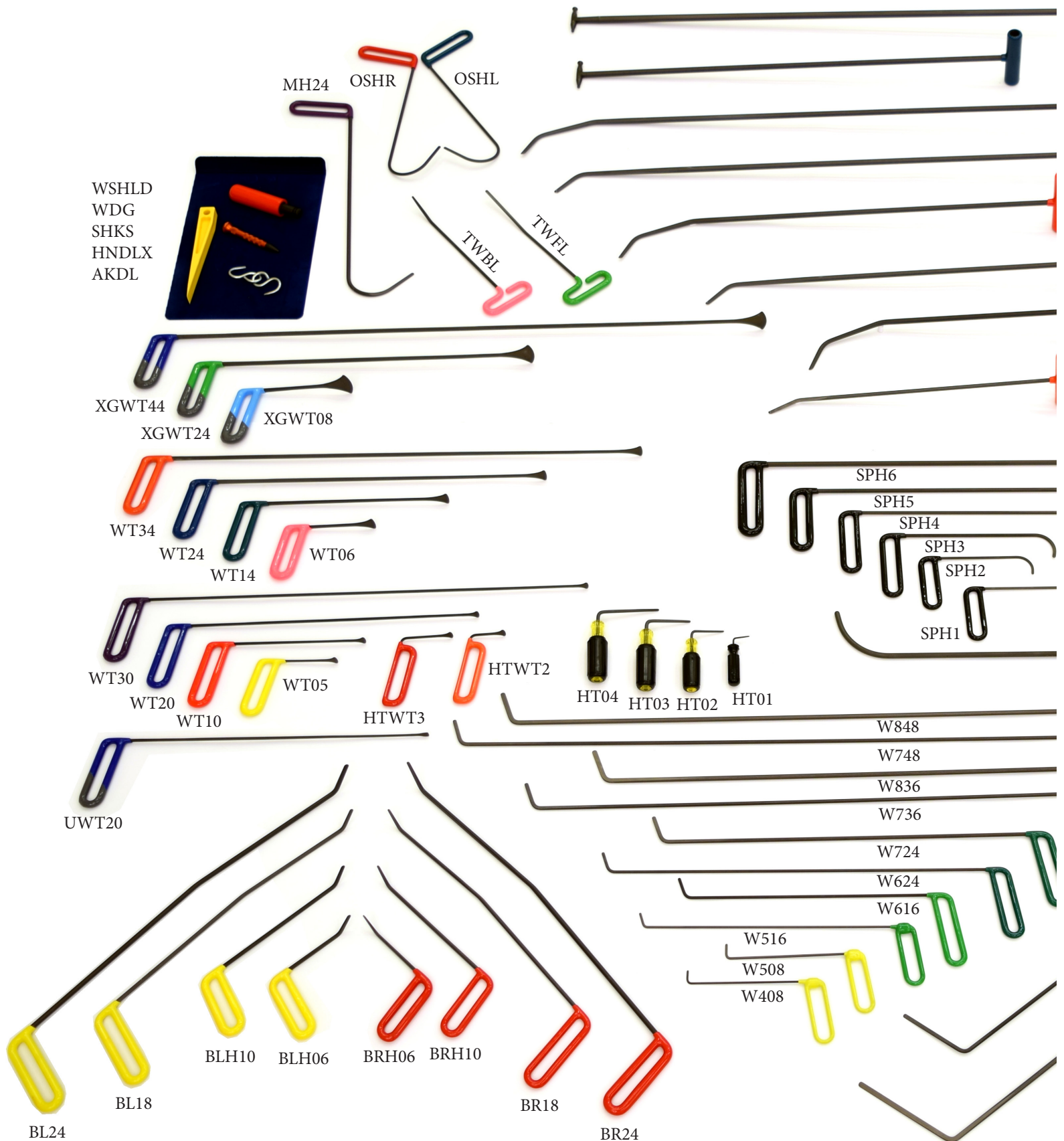

When you buy a PRO SET, at the time of purchase, you may take 35% off one of each Dentcraft Tool we manufacture to expand your set to suit your needs. (excluding collapsible rod set and tips)

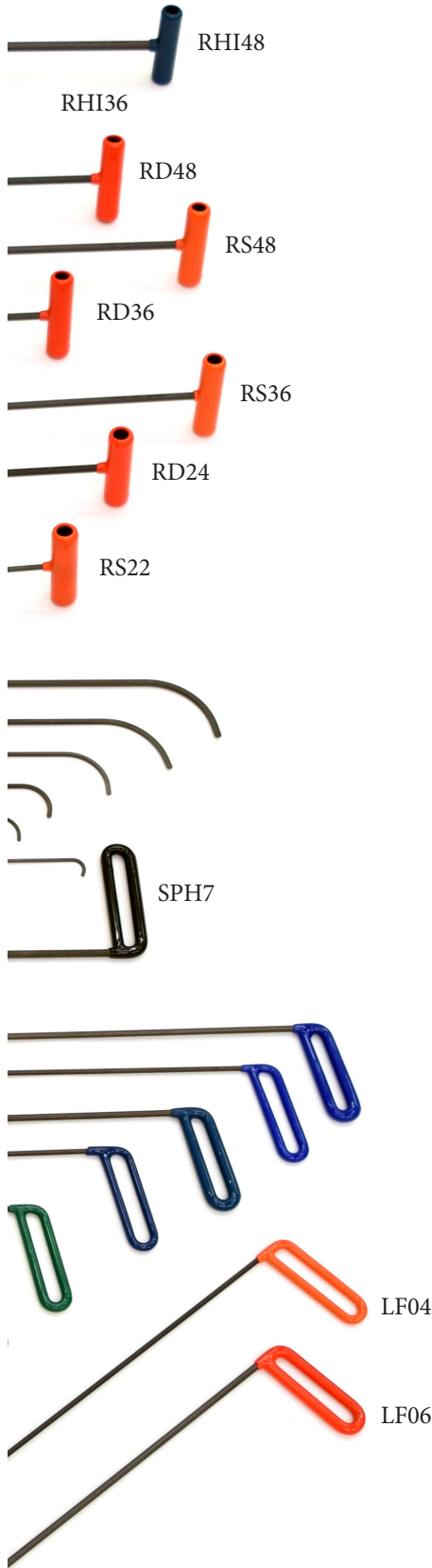

Item Number	Price	Description
8 RODS		
RHI48	\$149.95	Interchangeable Tip Hail Rod 5/8" diameter x 48"
RHI36	\$139.95	Interchangeable Tip Hail Rod 1/2" diameter x 36"
RD48	\$159.95	Double Bend Door Rod 1/2" diameter x 48"
RS48	\$134.95	Single Bend Door Rod 1/2" diameter x 48"
RD36	\$149.95	Double Bend Door Rod 7/16" diameter x 36"
RS36	\$129.95	Single Bend Door Rod 7/16" diameter x 36"
RD24	\$139.95	Double Bend Door Rod 7/16" diameter x 24"
RS22	\$84.95	Single Bend Door Rod 5/16" diameter x 22"
10 WIRES		
W408	\$26.95	.125 (1/8) diameter x 8"
W508	\$26.95	.150 (2.5/16) diameter x 8"
W516	\$26.95	.150 (2.5/16) diameter x 16"
W616	\$26.95	.183 (3/16) diameter x 16"
W624	\$26.95	.183 (3/16) diameter x 24"
W724	\$26.95	.243 (1/4) diameter x 24"
W736	\$26.95	.243 (1/4) diameter x 36"
W836	\$26.95	.306 (5/16) diameter x 36"
W748	\$26.95	.243 (1/4) diameter x 48"
W848	\$26.95	.306 (5/16) diameter x 48"
8 BRACE TOOLS		
BLH06 & BRH06	\$32.95	.243 (1/4) diameter x 6" Heavy Shaft
BLH10 & BRH10	\$32.95	.243 (1/4) diameter x 10" Heavy Shaft
BL18 & BR18	\$32.95	.243 (1/4) diameter x 18" Left & Right
BL24 & BR24	\$32.95	.306 (5/16) diameter x 24" Left & Right
LONG FLAGS		
LF06	\$32.95	.306 (5/16) diameter x 24" w/6" Flag
LF04	\$32.95	.243 (1/4) diameter x 24" w/4" Flag
T-HANDLES		
TWBL	\$24.95	.243 (1/4) diameter x 14" Blunt Tip
TWFL	\$24.95	.243 (1/4) diameter x 14" Flat Tip
3 HOOKS		
MH24	\$64.95	.306 (5/16) diameter x 24" Medium Hook
OSHR	\$54.95	.243 (1/4) diameter x 16" Offset Hook Right
OSHL	\$54.95	.243 (1/4) diameter x 16" Offset Hook Left
14 WHALE TAILS		
HTWT2	\$59.95	3/4" Tip x 2" Long
HTWT3	\$59.95	3/4" Tip x 3" Long
UWT20	\$64.95	1/2" Tip x 20" Long
WT05	\$59.95	3/4" Tip x 5" Long
WT10	\$64.95	3/4" Tip x 10" Long
WT20	\$64.95	3/4" Tip x 20" Long
WT30	\$64.95	3/4" Tip x 30" Long
WT06	\$64.95	1 1/8" Tip x 6" Long
WT14	\$64.95	1 1/8" Tip x 14" Long
WT24	\$64.95	1 1/8" Tip x 24" Long
WT34	\$79.95	1 1/8" Tip x 34" Long
XGWT08	\$84.95	2" Tip x 8" Long
XGWT24	\$84.95	2" Tip x 24" Long
XGWT44	\$104.95	2" Tip x 44" Long
4 Hand Tools		
HT01	\$16.95	1' Hand Tool
HT02	\$26.95	2' Hand Tool
HT03	\$26.95	3' Hand Tool
HT04	\$26.95	4' Hand Tool
7 SIDE PANEL HOOKS		
SPH1	\$32.95	.183 (3/16) diameter x 8" OAL w/1" Curve Flag
SPH2	\$32.95	.183 (3/16) diameter x 8" OAL w/1-1/2" Curve Flag
SPH3	\$32.95	.243 (1/4) diameter x 12" OAL w/2" Curve Flag
SPH4	\$32.95	.243 (1/4) diameter x 18" OAL w/2-1/2" Curve Flag
SPH5	\$32.95	.305 (5/16) diameter x 24" OAL w/3' Curve Flag
SPH6	\$32.95	.362 (3/8) diameter x 30" OAL w/3-1/2" Curve Flag
SPH7	\$32.95	.362 (3/8) diameter x 18" OAL w/3-1/2" Curve Ball End
5 ACCESSORIES		
AKDL	\$24.95	4" Aluminum Knockdown w/tip - 4-3/4" Overall
HNDLX	\$24.95	Threaded Handle Extender
WDG	\$7.95	1" Wide Window Wedge 9" Length
SHKS	\$4.95	S-Hooks
WSHLD	\$19.95	Window Shield 10" x 14" Velvet Lined Lexan

Company Set 72 Pieces \$1,995

35% Discount Off Individual Prices

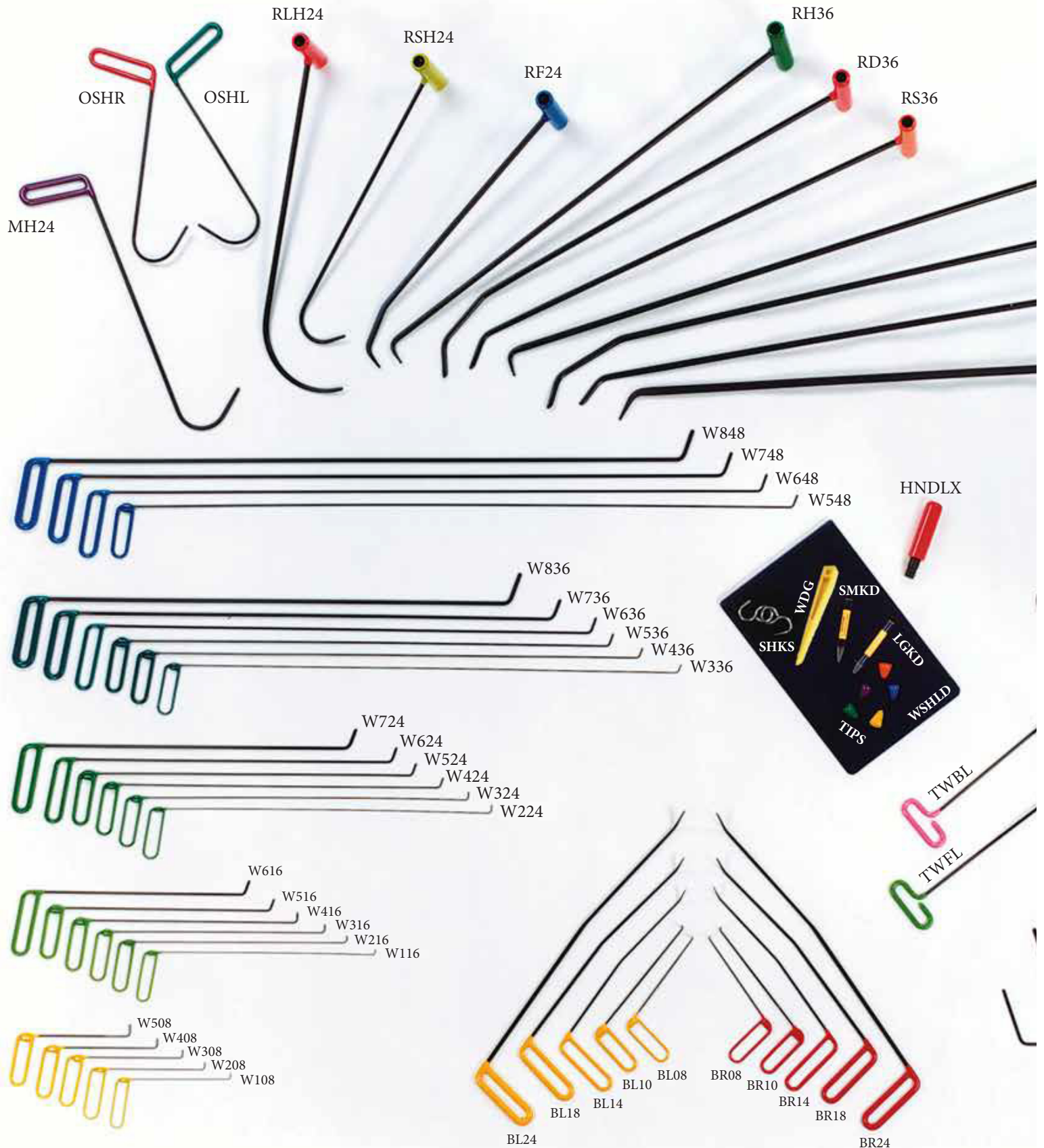

When you buy a COMPANY SET, at the time of purchase, you may take 35% off one of each Dentcraft Tool we manufacture to expand your set to suit your needs. (excluding collapsible rod set and tips)



Item Number	Price	Description
10 RODS		
RB56	\$125.95	Bertha Rod 5/8" diameter x 56"
RS48	\$134.95	Single Bend Door Rod 1/2" diameter x 48"
RD48	\$159.95	Double Bend Door Rod 1/2" diameter x 48"
RH48	\$109.95	Hail Rod 1/2" diameter x 48"
RS36	\$129.95	Single Bend Door Rod 7/16" diameter x 36"
RD36	\$149.95	Double Bend Door Rod 7/16" diameter x 36"
RH36	\$99.95	Hail Rod 7/16" diameter x 36"
RF24	\$99.95	Fender Rod 7/16" diameter x 24"
RSH24	\$99.95	Small Hook 5/16" diameter x 24"
RLH24	\$149.95	Large Hook 7/16" diameter x 24"
27 WIRES		
W848	\$26.95	.306 (5/16) diameter x 48"
W748	\$26.95	.243 (1/4) diameter x 48"
W648	\$26.95	.183 (3/16) diameter x 48"
W548	\$26.95	.150 (2.5/16) diameter x 48"
W836	\$26.95	.306 (5/16) diameter x 36"
W736	\$26.95	.243 (1/4) diameter x 36"
W636	\$26.95	.183 (3/16) diameter x 36"
W536	\$26.95	.150 (2.5/16) diameter x 36"
W436	\$26.95	.125 (1/8) diameter x 36"
W336	\$26.95	.105 diameter x 36"
W724	\$26.95	.243 (1/4) diameter x 24"
W624	\$26.95	.183 (3/16) diameter x 24"
W524	\$26.95	.150 (2.5/16) diameter x 24"
W424	\$26.95	.125 (1/8) diameter x 24"
W324	\$26.95	.105 diameter x 24"
W224	\$26.95	.090 diameter x 24"
W616	\$26.95	.183 (3/16) diameter x 16"
W516	\$26.95	.150 (2.5/16) diameter x 16"
W416	\$26.95	.125 (1/8) diameter x 16"
W316	\$26.95	.105 diameter x 16"
W216	\$26.95	.090 diameter x 16"
W116	\$26.95	.075 diameter x 16"
W508	\$26.95	.150 (2.5/16) diameter x 8"
W408	\$26.95	.125 (1/8) diameter x 8"
W308	\$26.95	.105 diameter x 8"
W208	\$26.95	.090 diameter x 8"
W108	\$26.95	.075 diameter x 8"
10 BRACE TOOLS (5 Left & 5 Right)		
BL24 & BR24	\$32.95	.306 (5/16) diameter x 24" Left & Right
BL18 & BR18	\$32.95	.243 (1/4) diameter x 18" Left & Right
BL14 & BR14	\$32.95	.180 (3/16) diameter x 14" Left & Right
BL10 & BR10	\$32.95	.150 (2.5/16) diameter x 10" Left & Right
BL08 & BR08	\$32.95	.125 (1/8) diameter x 8" Left & Right
LONG FLAGS		
LF06	\$32.95	.306 (5/16) diameter x 24" w/ 6" Flag
LF04	\$32.95	.243 (1/4) diameter x 24" w/ 4" Flag
T-HANDLES		
TWBL	\$24.95	.243 (1/4) diameter x 14" Blunt Tip
TWFL	\$24.95	.243 (1/4) diameter x 14" Flat Tip
3 HOOKS		
MH24	\$64.95	.306 (5/16) diameter x 24" Medium Hook
OSHR	\$54.95	.243 (1/4) diameter x 16" Offset Hook Right
OSHL	\$54.95	.243 (1/4) diameter x 16" Offset Hook Left
5 WHALE TAILS		
WT24	\$64.95	24" Whale Tail (1-1/8" Wide Tip)
WT14	\$64.95	14" Whale Tail (1-1/8" Wide Tip)
WT06	\$64.95	6" Whale Tail (1-1/8" Wide Tip)
WT20	\$64.95	20" Whale Tail (3/4" Wide Tip)
UWT20	\$64.95	20" Ultra-Thin Whale Tail (1/2" Wide Tip)
8 HAND TOOLS		
HT04	\$26.95	4" Hand Tool
HT03	\$26.95	3" Hand Tool
HT02	\$26.95	2" Hand Tool
HT01	\$16.95	1" Hand Tool
HT12	\$16.95	1/2" Hand Tool
HTBL	\$26.95	6" Hand Tool w/ Blunt Tip
HTFL	\$26.95	6" Hand Tool w/ Flat Tip
HTCV	\$26.95	6" Hand Tool w/ Curved Tip
5 ACCESSORIES		
HNDLX	\$24.95	Threaded Handle Extender
WSHLD	\$19.95	10" x 14" Velvet Lined Lexan Window Shield
WDG	\$7.95	9" Long x 1" Wide Window Wedge
LGKD	\$6.95	Large Tip Acrylic Knock Down
SMKD	\$6.95	Small Tip Acrylic Knock Down
SHKS	\$4.95	S-Hooks

Tech Set - \$1,350.00

The Technician Set gives you the basic and most used tools necessary to repair door dings and hail damage on any car.

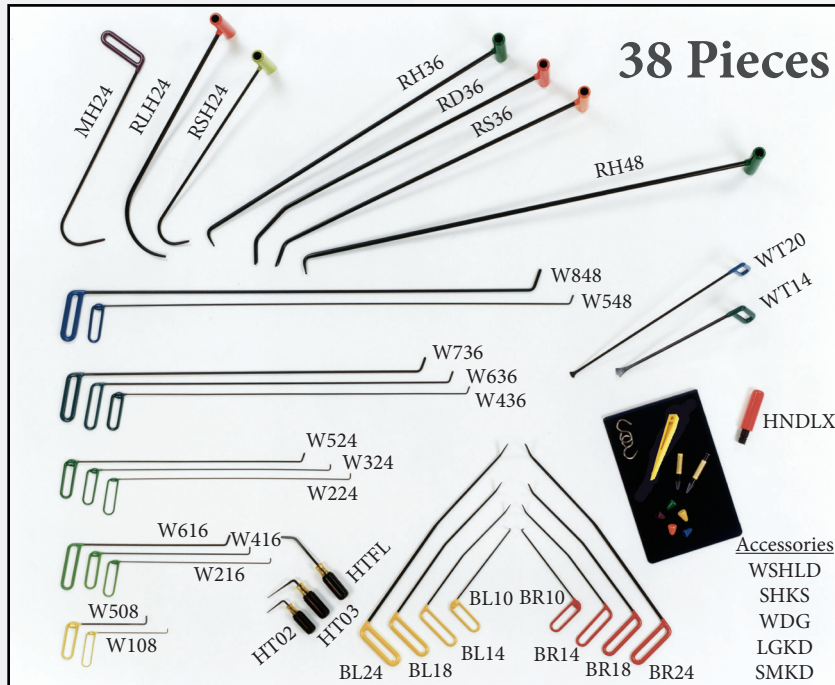

38 Pieces

RODS

RLH24
RSH24
RH36
RD36
RS36
RH48

HOOK

MH24

WHALE TAILS

WT20
WT14

HAND TOOLS

HT02
HT03
HTFL

WIRES

W848
W548
W736
W636
W436
W524
W324
W224
W616
W416
W216
W508
W108

BRACE TOOLS

BL10
BL14
BL18
BL24
BR10
BR14
BR18
BR24

ACCESSORIES

WSHLD
SHKS
WDG
HNDLX
LGKD
SMKD

Hail Compliment Set - \$630.00

This set compliments the Tech Set. *This is not recommended or appropriate as a stand-alone set.*

RODS

RB56
RF24
T-HANDLES
TWBL
TWFL
WHALE TAILS
WT24
UWT20
WT06

WIRES

W536
W336
W624
W424
W516
W316
W116
W408
W308
W208

BRACE TOOLS

BL08
BR08
Hand Tools
HT12
HT01
HT04

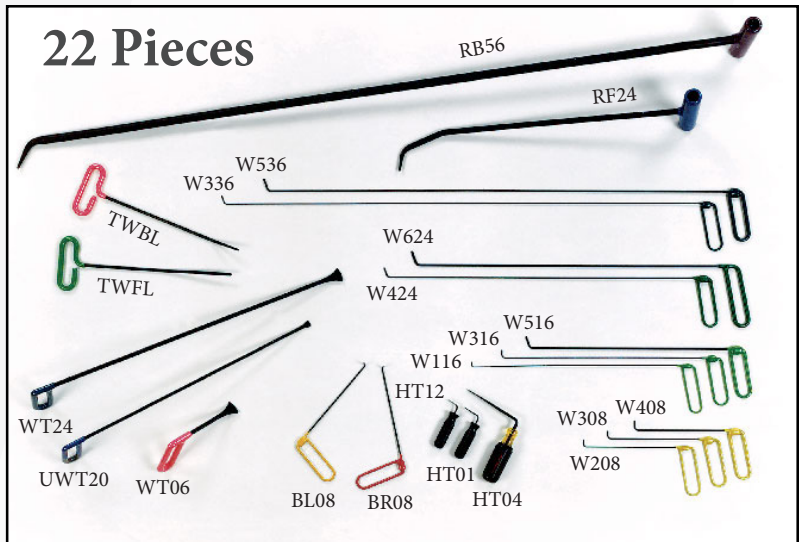

22 Pieces

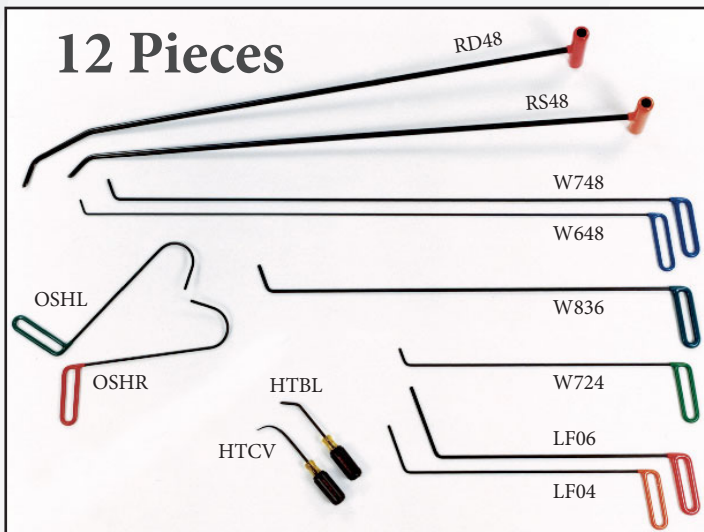

12 Pieces

Door Compliment Set - \$495.00

This set compliments the Tech Set. *This is not recommended or appropriate as a stand-alone set.*

RODS

RD48
RS48

WIRES

W748
W648
W836
W724

FLAGS

LF06
LF04

OFFSET HOOKS

OSHL
OSHR

HAND TOOLS

HTBL
HTCV

Starter Hail Set - \$630.00

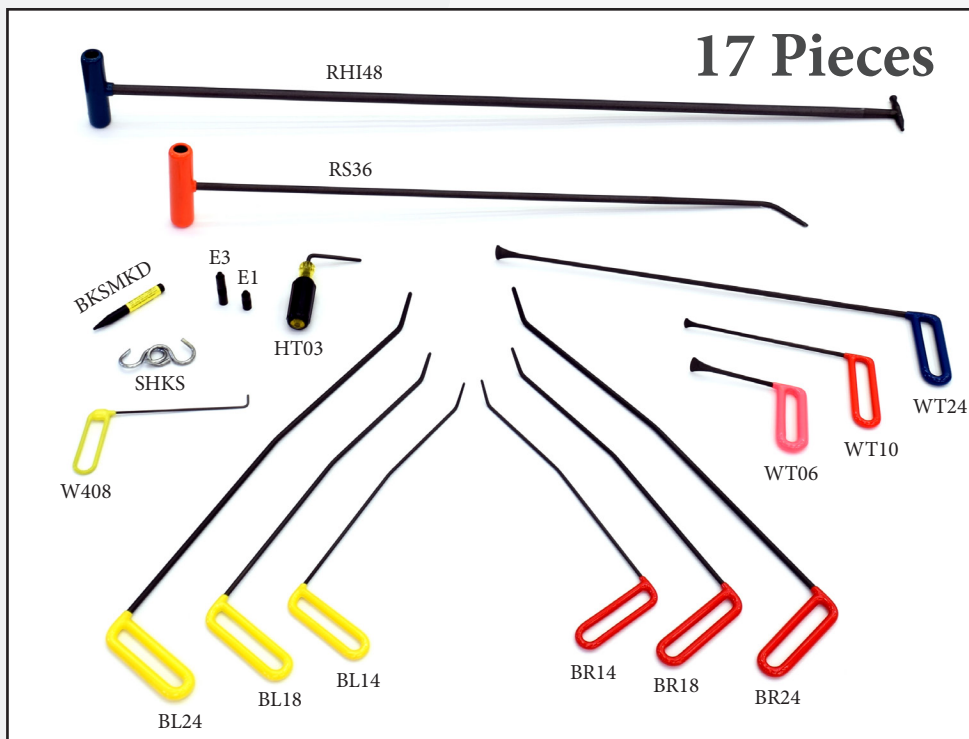

RODS

RHI48
RS36

WHALE TAILS

WT24
WT10
WT06

BRACE TOOLS

BL14
BL18
BL24
BR14
BR18
BR24

WIRES

W408

HAND TOOLS

HT03

EXTENSIONS

E1

E3

ACCESSORIES

BK-SMKD
SHKS

Starter Side Panel Set - \$630.00

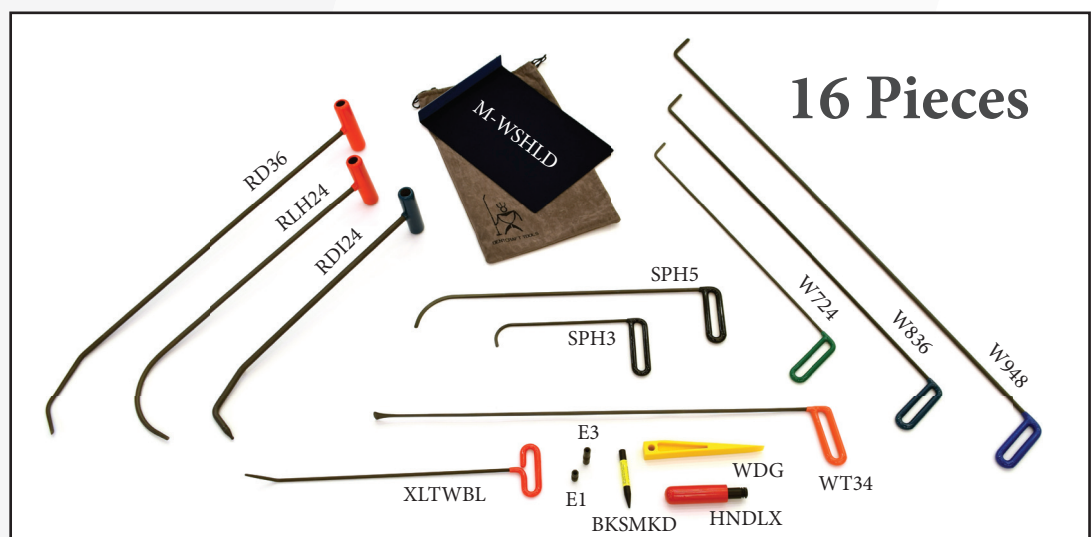

RODS

RD36
RLH24
RDI24

WIRES

W724
W836

W948

SIDE PANELS

SPH3
SPH5

WHALE TAIL

WT34

T-HANDLE

XL-TWBL

EXTENSIONS

E1

E3

ACCESSORIES

M-WSHLD
BK-SMKD
WDG
HNDLX

Rod Set - \$1,042.00

10 Pieces

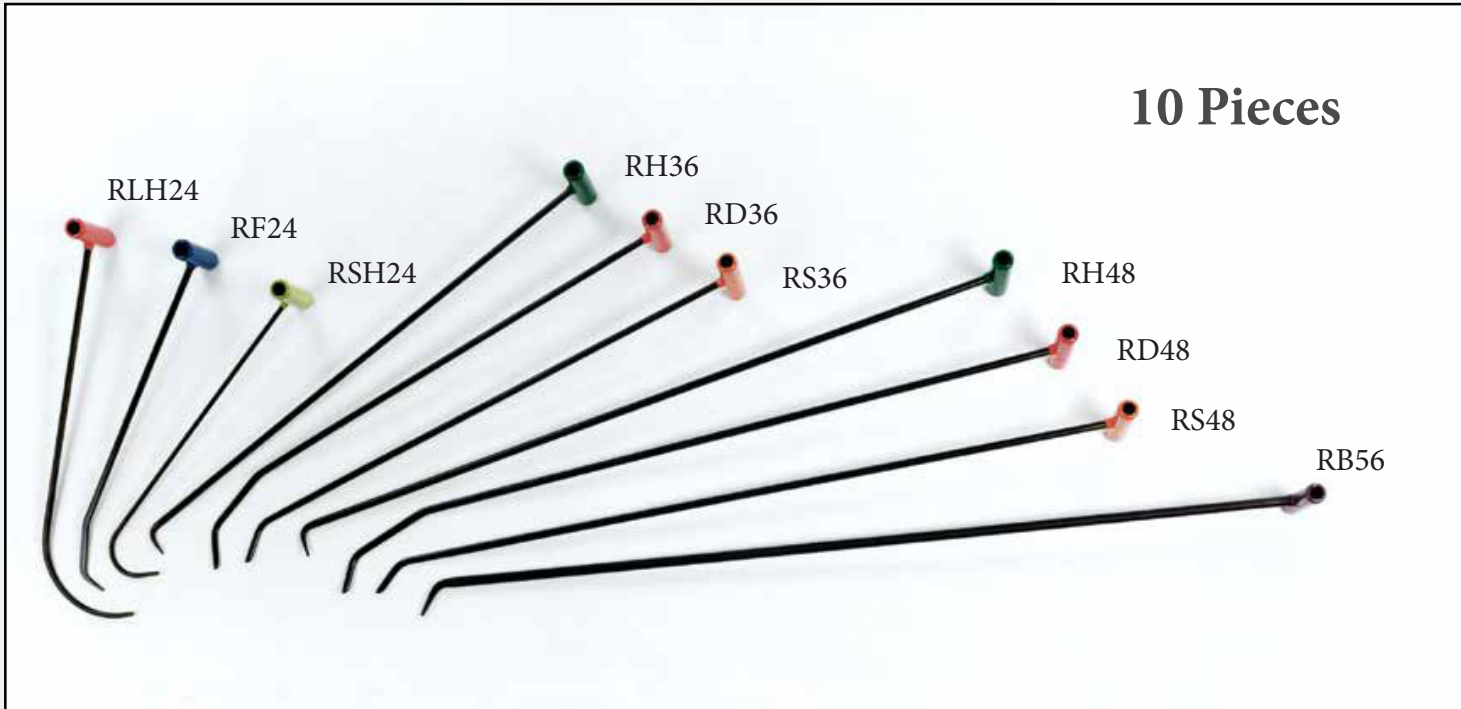

RB56	\$125.95	Bertha Rod 5/8" diameter x 56"
RS48	\$134.95	Single Bend Door Rod 1/2" diameter x 48"
RD48	\$159.95	Double Bend Door Rod 1/2" diameter x 48"
RH48	\$109.95	Hail Rod 1/2" diameter x 48"
RS36	\$129.95	Single Bend Door Rod 7/16" diameter x 36"
RD36	\$149.95	Double Bend Door Rod 7/16" diameter x 36"
RH36	\$99.95	Hail Rod 7/16" diameter x 36"
RSH24	\$99.95	Small Hook Rod 5/16" diameter x 24"
RF24	\$99.95	Fender Rod 7/16" diameter x 24"
RLH24	\$149.95	Large Hook Rod 7/16" diameter x 24"

Threaded
Handle
Extender



HNDLX
\$24.95



HANDLES - Dentcraft's rod handles are large and comfortable for heavy-duty work. The quick connect extender adds extra length to either side of the grip when needed.

LARGE HOOKS - Dentcraft Tools large hook is a tapered marquise design, tempered to produce the most versatile and efficient tool, unparalleled in strength.

SMALL HOOK - This tool also has a tapered marquise design.

RODS - Dentcraft Rods have the highest strength to size ratio in the industry and are sized for standard hole clearance (i.e., our 1/2" rod is actually 6 thousandths under 1/2" for ease of use in a standard hole)

TIPS - Dentcraft's single and double bend tips are a tapered, teardrop design. This allows maximum strength with minimum thickness, a smooth, non-dragging tool with a knife-edge on the inside for cutting glue between skin and brace. The tips of the hail rods are all precision turned to ensure the desired hail rod tip and taper consistency.

Truck Bed Rods

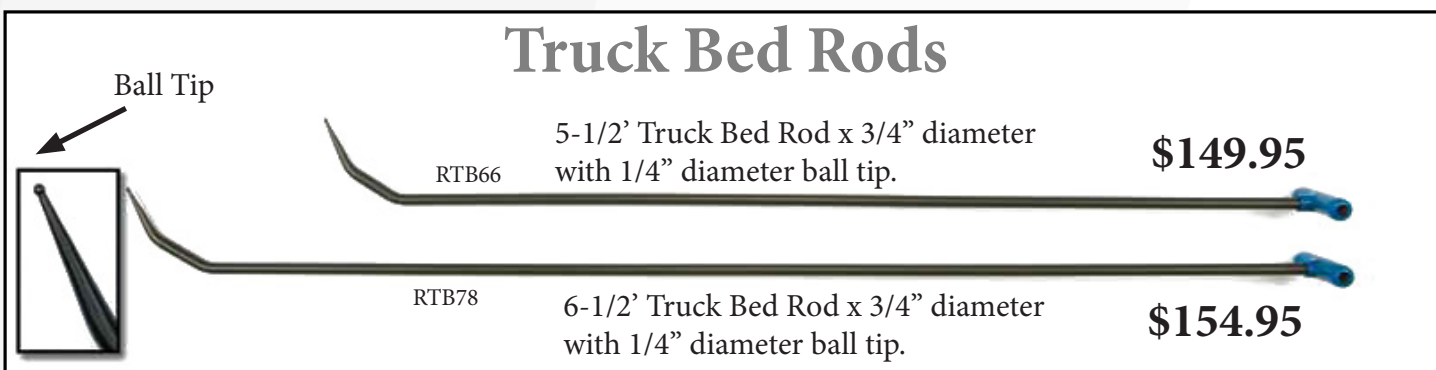

More Rods

Dentcraft's tip allows for consistent performance from all angles of use.

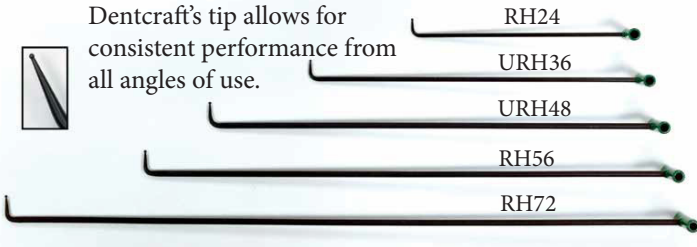

Upsize Hail Rods

RH24	\$79.95	24" Hail Rod x 7/16" dia.
URH36	\$104.95	Upsized 36" Hail Rod x 1/2" dia.
URH48	\$119.95	Upsized 48" Hail Rod x 5/8" dia.
RH56	\$129.95	56" Hail Rod x 5/8" dia.
RH72	\$139.95	72" (6') Hail Rod x 5/8" dia.

Mini Fender Rods

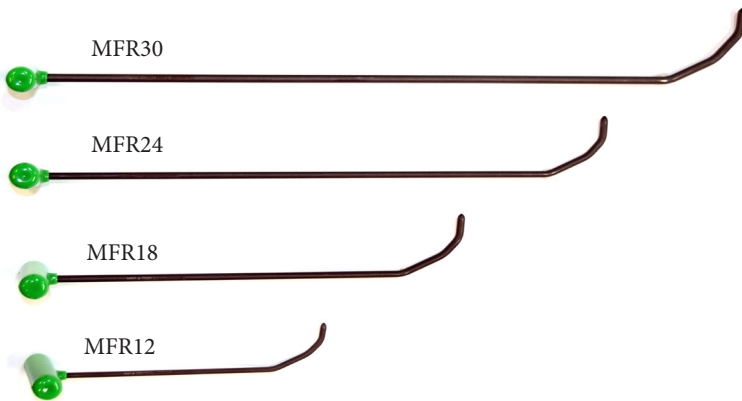

MFR30	\$59.95	30" Triple Bend x 3/8" dia.
MFR24	\$59.95	24" Triple Bend x 5/16" dia.
MFR18	\$54.95	18" Triple Bend x 5/16" dia.
MFR12	\$54.95	12" Triple Bend x 1/4" dia.
MFRST	\$199.95	4pc Mini Fender Rod Set

Fender Rod



RF36	\$109.95	36" Fender Rod x 7/16" dia.
-------------	-----------------	-----------------------------

Single & Double Bend Rods



RS22	\$84.95	22" Single Bend Door Rod x 5/16" dia.
RD24	\$139.95	24" Double Bend Door Rod x 7/16" dia.

Single & Double Bend Rods



RD60	\$169.95	60" Double Bend Rod x 9/16" dia.
-------------	-----------------	----------------------------------



RD30	\$104.95	30" Double Bend Rod x 3/8" dia.
-------------	-----------------	---------------------------------

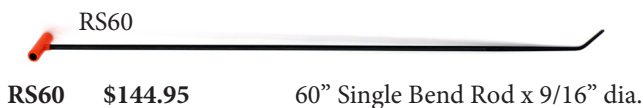

RS60	\$144.95	60" Single Bend Rod x 9/16" dia.
-------------	-----------------	----------------------------------



RS30	\$99.95	30" Single Bend Rod x 3/8" dia.
-------------	----------------	---------------------------------

Brace Tools

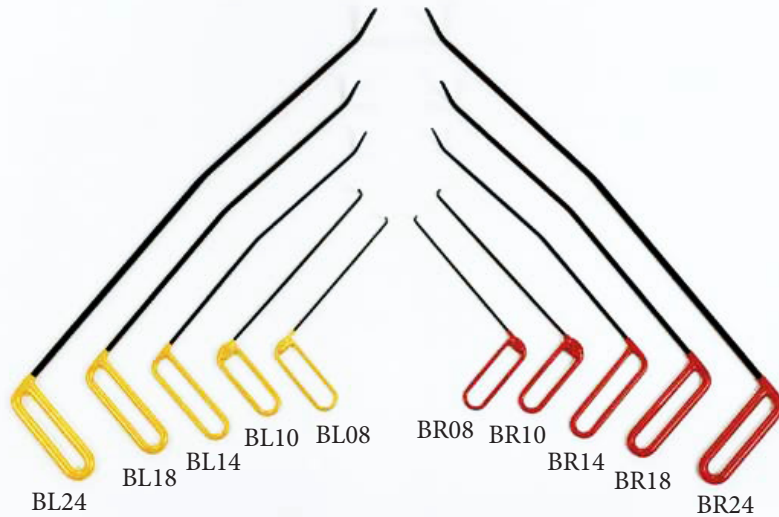

BL24	\$32.95	.306 (5/16) x 24" Left
BR24	\$32.95	.306 (5/16) x 24" Right
BL18	\$32.95	.243 (1/4) x 18" Left
BR18	\$32.95	.243 (1/4) x 18" Right
BL14	\$32.95	.183 (3/16) x 14" Left
BR14	\$32.95	.183 (3/16) x 14" Right
BL10	\$32.95	.148 (2.5/16) x 10" Left
BR10	\$32.95	.148 (2.5/16) x 10" Right
BL08	\$32.95	.125 (1/8) x 8" Left
BR08	\$32.95	.125 (1/8) x 8" Right

BRC10 **\$259.95**
(10pc Brace Set (5 Left, 5 Right))

BRC6 **\$159.95**
6pc Brace Set (6 Largest, 3 Left and 3 Right)

Brace Tools - The brace tools are left and right-handed specific for ease of use around braces. The 10 degree angle is moved well back to maximize reach and minimize high spots. The handle is rotated 12 degrees to improve ergonomics. For hail damage, these are a must have for every dent tech.

Handle Colors - The brace tools are color specific by right/left handed tools. (Yellow for Left, Red for Right)

Straight and Heavy Shaft Brace Tools - Many techs have requested variations of our popular Left and Right Brace Set. By request, we now have Left and Right 14", 18", and 24" length straight brace tools. Also in Left and Right, we now have 1/4" diameter (heavy) 6" and 10" brace tools.

Straight & Heavy Shaft Brace Tools

BLS24	\$32.95	.306 (5/16) x 24" Straight Shaft
BRS24	\$32.95	.306 (5/16) x 24" Straight Shaft
BLS18	\$32.95	.243 (1/4) x 18" Straight Shaft
BRS18	\$32.95	.243 (1/4) x 18" Straight Shaft
BLS14	\$32.95	.183 (3/16) x 14" Straight Shaft
BRS14	\$32.95	.183 (3/16) x 14" Straight Shaft
BLH10	\$32.95	.243 (1/4) x 10" Heavy Shaft
BRH10	\$32.95	.243 (1/4) x 10" Heavy Shaft
BLH06	\$32.95	.243 (1/4) x 6" Heavy Shaft
BRH06	\$32.95	.243 (1/4) x 6" Heavy Shaft

SBRC10 **\$259.95**
10pc (5 Left, 5 Right) Straight/Heavy Brace Set

SBRC6 **\$159.95**
6pc (6 Largest) Straight Brace Set

BRH4 **\$109.95**
4pc (4 Smallest) Heavy Shaft Brace Set

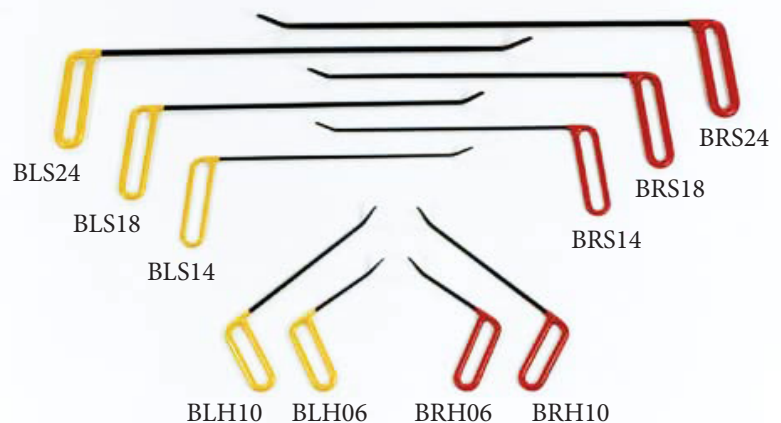

Sharp Tip Brace Tools

6pc Sharp Tip Brace Tool Set

PBRC06

\$159.95

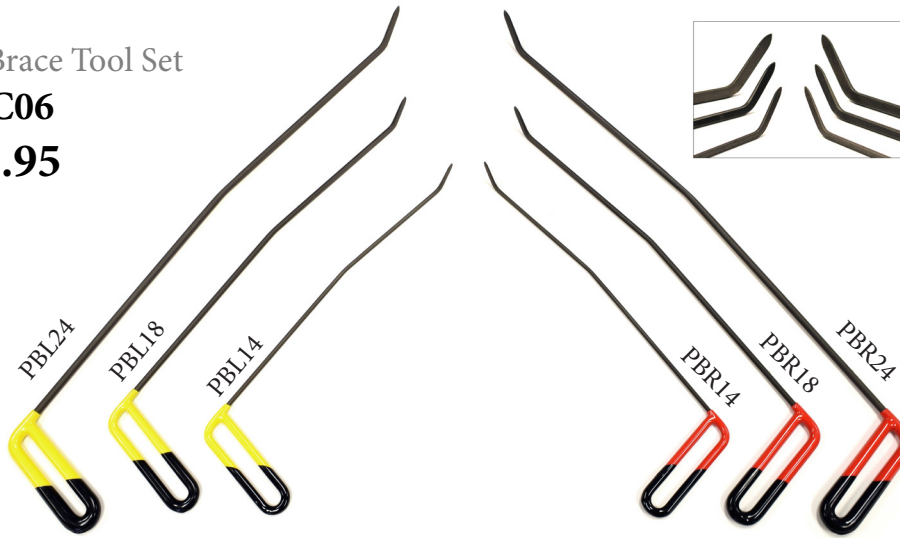

PBL24	\$32.95
PBR24	\$32.95
PBL18	\$32.95
PBR18	\$32.95
PBL14	\$32.95
PBR14	\$32.95

.306 (5/16) x 24" Sharp Tip Left
.306 (5/16) x 24" Sharp Tip Right
.243 (1/4) x 18" Sharp Tip Left
.243 (1/4) x 18" Sharp Tip Right
.183 (3/16) x 14" Sharp Tip Left
.183 (3/16) x 14" Sharp Tip Right

Sharp Tip Straight Brace Tools

6pc Sharp Tip
Straight Brace Tool Set

SSBRC6

\$159.95

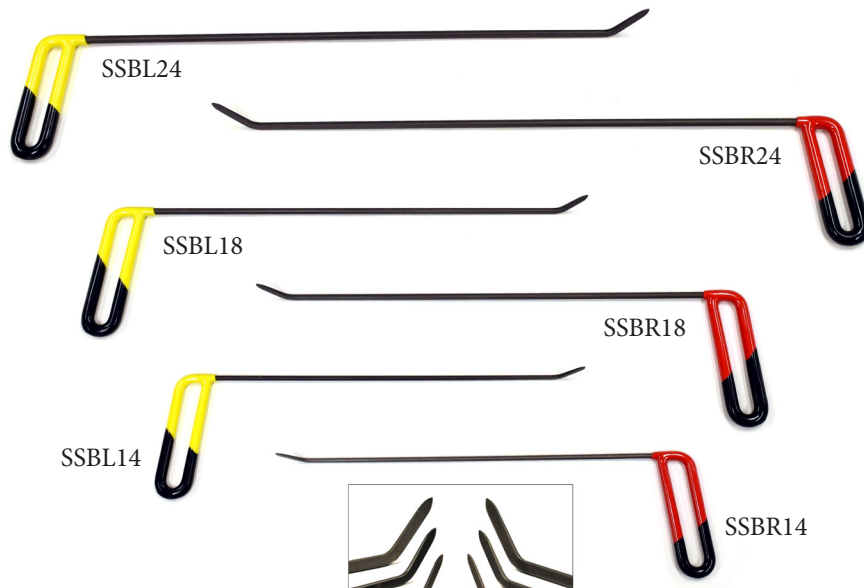

SSBL24	\$32.95	.306 (5/16) x 24" Sharp Tip Left
SSBR24	\$32.95	.306 (5/16) x 24" Sharp Tip Right
SSBL18	\$32.95	.243 (1/4) x 18" Sharp Tip Left
SSBR18	\$32.95	.243 (1/4) x 18" Sharp Tip Right
SSBL14	\$32.95	.183 (3/16) x 14" Sharp Tip Left
SSBR14	\$32.95	.183 (3/16) x 14" Sharp Tip Right

Whale Tails



ULTRA-THIN WHALE TAILS
Designed to fit in 7/16" hole or larger

UWT05	\$59.95	1/2" Tip x 5"
UWT10	\$64.95	1/2" Tip x 10"
UWT15	\$64.95	1/2" Tip x 15"
UWT20	\$64.95	1/2" Tip x 20"
UWT30	\$64.95	1/2" Tip x 30"
UWT40	\$79.95	1/2" Tip x 40"

6pc Ultra-Thin Whale Tail Set

UWTST6
\$314.95

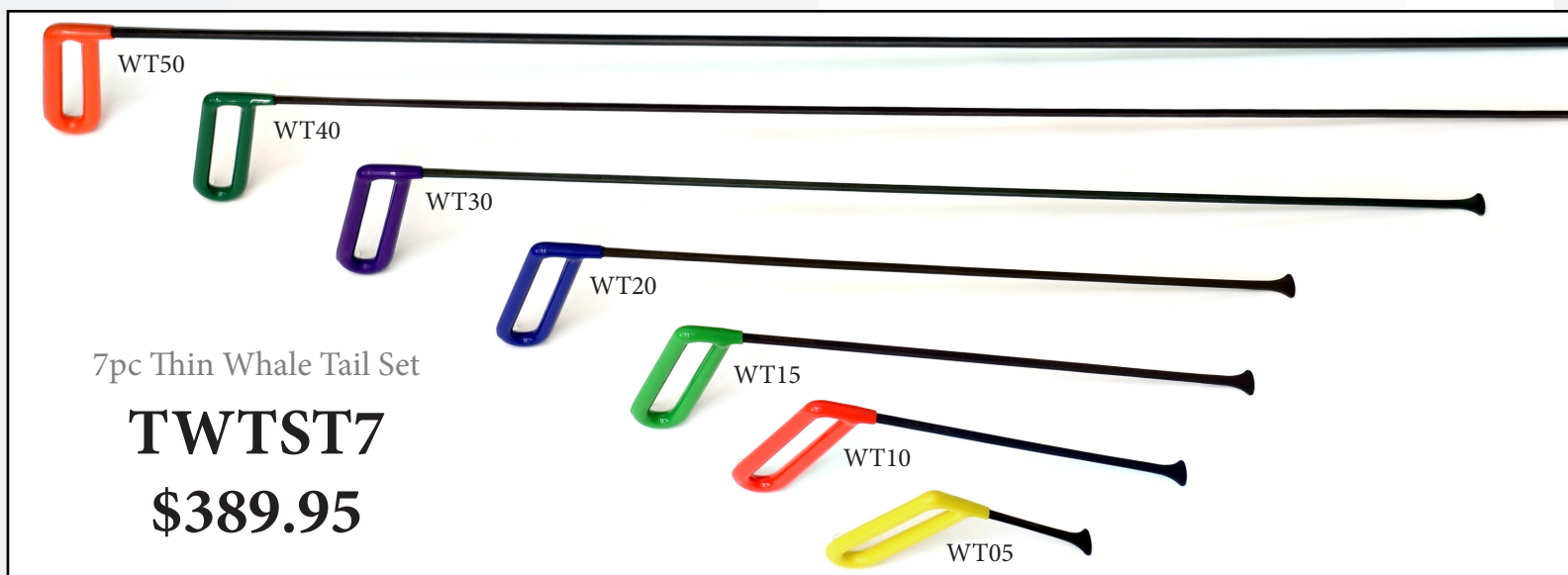

7pc Thin Whale Tail Set

TWTST7
\$389.95

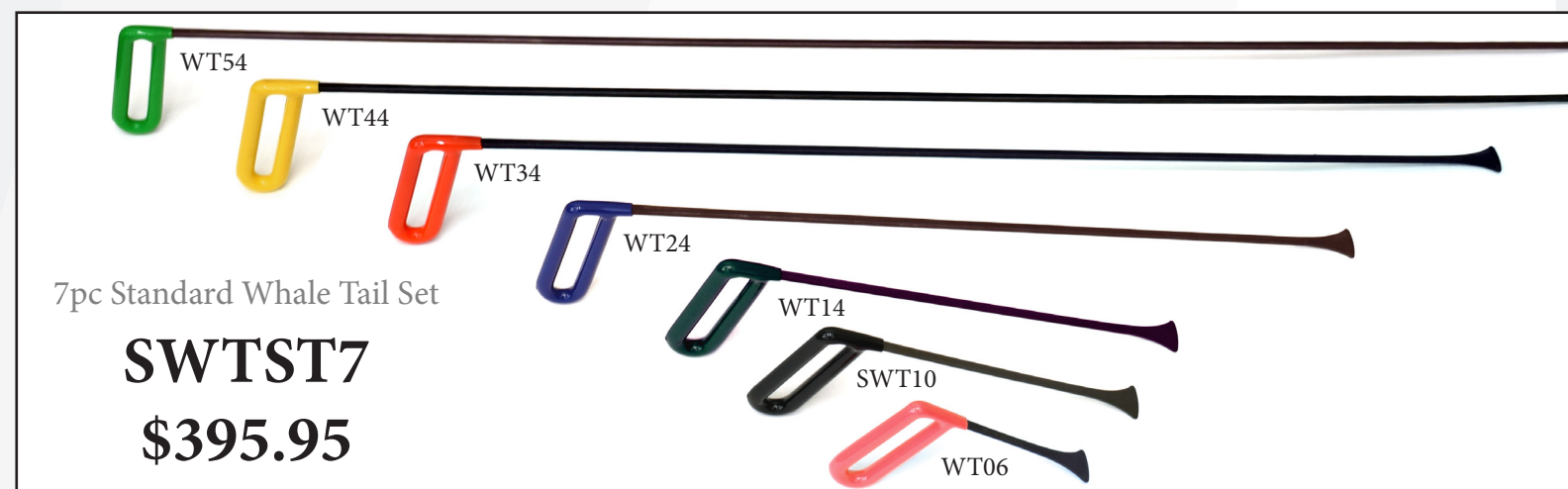

7pc Standard Whale Tail Set

SWTST7
\$395.95

Whale Tails

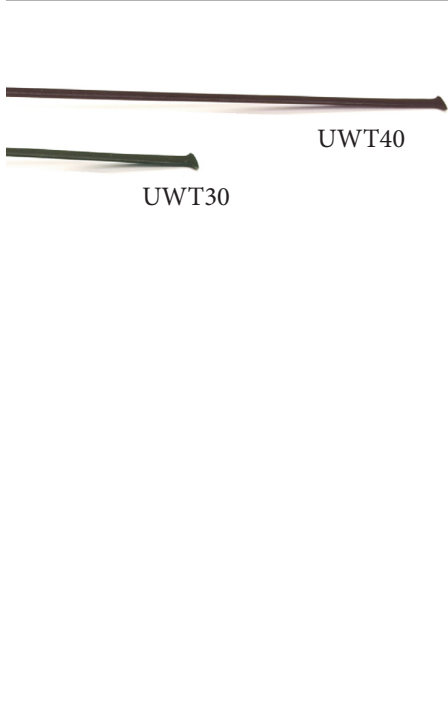

- **Ultra-Thin** Whale Tail series is 1/2 inch wide at the tip and will fit into a 7/16 inch or larger hole.
 - **Thin** Whale Tail series is 3/4 inch wide at the tip and 1/8 inch thick at the thickest point. Fits in 9/16 inch or larger hole.
 - **Standard** Whale Tail series is 1-1/8 inch wide at the tip. Fits in 1 inch or larger hole
 - **Wide** Whale Tail series is 1-1/2 inches wide at the tip. Fits in 1-1/4 inch or larger hole
 - **Extra-Wide** Whale Tail series is 2 inches wide at the tip. Fits in 1-1/2 inch or larger hole
 - **Hammer Head** Whale Tail series is 3 inches wide at the tip. Fits in 2-1/4 inch or larger hole.
- The shafts are all rounded at the top to minimize lines and high spots. The rate of taper and flair is designed to torque evenly as possible for the best response and best feel.

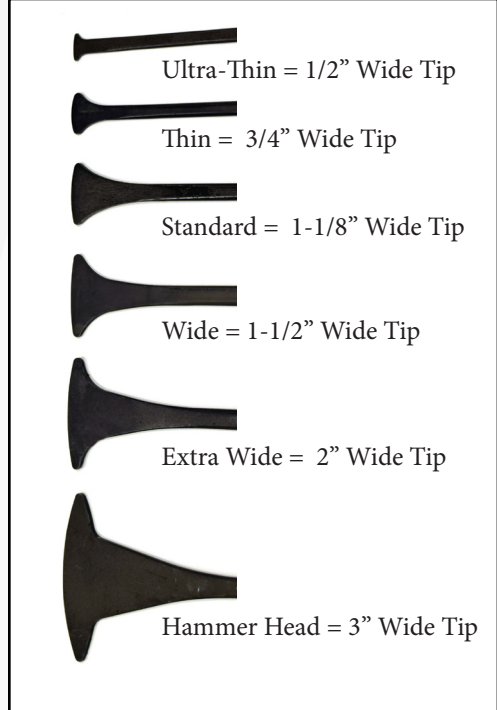

THIN WHALE TAILS
Designed to fit in 9/16" hole or larger

WT05	\$59.95	3/4" Tip x 5"
WT10	\$64.95	3/4" Tip x 10"
WT15	\$64.95	3/4" Tip x 15"
WT20	\$64.95	3/4" Tip x 20"
WT30	\$64.95	3/4" Tip x 30"
WT40	\$79.95	3/4" Tip x 40"
WT50	\$89.95	3/4" Tip x 50"

MIX & MATCH

1-2 WT's = Individual Price

3-5 WT's = 15% off Individual Price

6-11 WT's = 20% off Individual Price

12 or more WT's = 25% off Individual Price

(Mix & Match includes all Whale Tails)

Standard Whale Tails
Designed to fit in 1" hole or larger

WT06	\$64.95	1-1/8" Tip x 6"
SWT10	\$64.95	1-1/8" Tip x 10"
WT14	\$64.95	1-1/8" Tip x 14"
WT24	\$64.95	1-1/8" Tip x 24"
WT34	\$79.95	1-1/8" Tip x 34"
WT44	\$84.95	1-1/8" Tip x 44"
WT54	\$94.95	1-1/8" Tip x 54"

20pc Whale Tail Set

(All Whale Tails on this page)

WTST20

\$995.95

Whale Tails

6pc Wide Whale Tail Set

GWTST6

\$454.95

Wide Whale Tails
Designed to fit in 1-1/4" hole or larger

GWT08	\$84.95	1-1/2" Tip x 8"
GWT14	\$84.95	1-1/2" Tip x 14"
GWT24	\$84.95	1-1/2" Tip x 24"
GWT34	\$99.95	1-1/2" Tip x 34"
GWT44	\$104.95	1-1/2" Tip x 44"
GWT54	\$114.95	1-1/2" Tip x 54"

GWTST12
(GWTST6 + XGWTST6)
\$859.95

6pc Xtra Wide Whale Tail Set

XGWTST6

\$454.95

Xtra Wide Whale Tails
Designed to fit in 1-1/2" hole or larger

XGWT08	\$84.95	2" Tip x 8"
XGWT14	\$84.95	2" Tip x 14"
XGWT24	\$84.95	2" Tip x 24"
XGWT34	\$99.95	2" Tip x 34"
XGWT44	\$104.95	2" Tip x 44"
XGWT54	\$114.95	2" Tip x 54"

6pc Hammer Head Whale Tail Set

HHWTST6

\$484.95

Hammer Head Whale Tails
Designed to fit in 2-1/2" hole or larger

HHWT08	\$89.95	3" Tip x 8"
HHWT14	\$89.95	3" Tip x 14"
HHWT24	\$89.95	3" Tip x 24"
HHWT34	\$104.95	3" Tip x 34"
HHWT44	\$112.95	3" Tip x 44"
HHWT54	\$119.95	3" Tip x 54"

Whale Tails

6pc Hand Tool Whale Tail Set

HTWTST6

\$284.95



Hand Tool Whale Tails

HTWU2	\$59.95	1/2" Tip x 2"
HTWU3	\$59.95	1/2" Tip x 3"
HTWT2	\$59.95	3/4" Tip x 2"
HTWT3	\$59.95	3/4" Tip x 3"
HTWS2	\$59.95	1-1/8" Tip x 2"
HTWS3	\$59.95	1-1/8" Tip x 3"

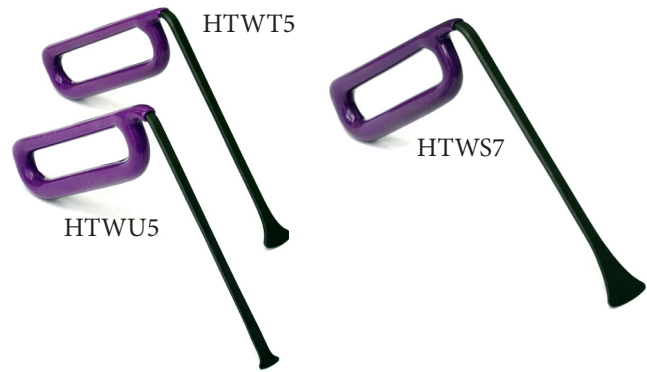

Hand Tool Whale Tails

HTWU5	\$59.95	1/2" Tip x 5"
HTWT5	\$59.95	3/4" Tip x 5"
HTWS7	\$59.95	1-1/8" Tip x 7"

9pc Hand Tool Whale Tail Set

HTWTST9

\$429.95

(HTWTST6 + HTWS7 + HTWT5 + HTWU5)



4pc Wide & Xtra Wide Hand Tool Whale Tail Set

FHTST

\$269.95

Wide & Extra Wide Hand Tools

GHT04	\$79.95	1-1/2" Tip x 4"
GHT06	\$79.95	1-1/2" Tip x 6"
XGHT04	\$79.95	2" Tip x 4"
XGHT06	\$79.95	2" Tip x 6"

Door Whale Tails

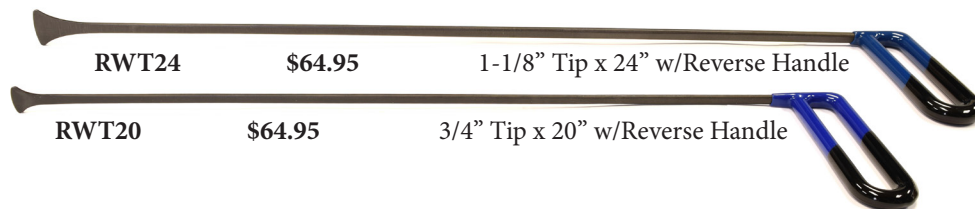

RWT24 **\$64.95** 1-1/8" Tip x 24" w/Reverse Handle

RWT20 **\$64.95** 3/4" Tip x 20" w/Reverse Handle

(same tool, same bevel, different handle configuration)

Door Whale Tail

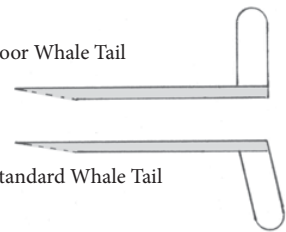

Standard Whale Tail

These Whale Tails are made to the same specifications, only with reverse handles. **These are ideal for working behind braces in doors. The reverse handle will clear the glass and posts while the bevel tracks to the outside near the skin, allowing better access.** Door Whale Tails are designated by the black tip.

Side Panel Hooks

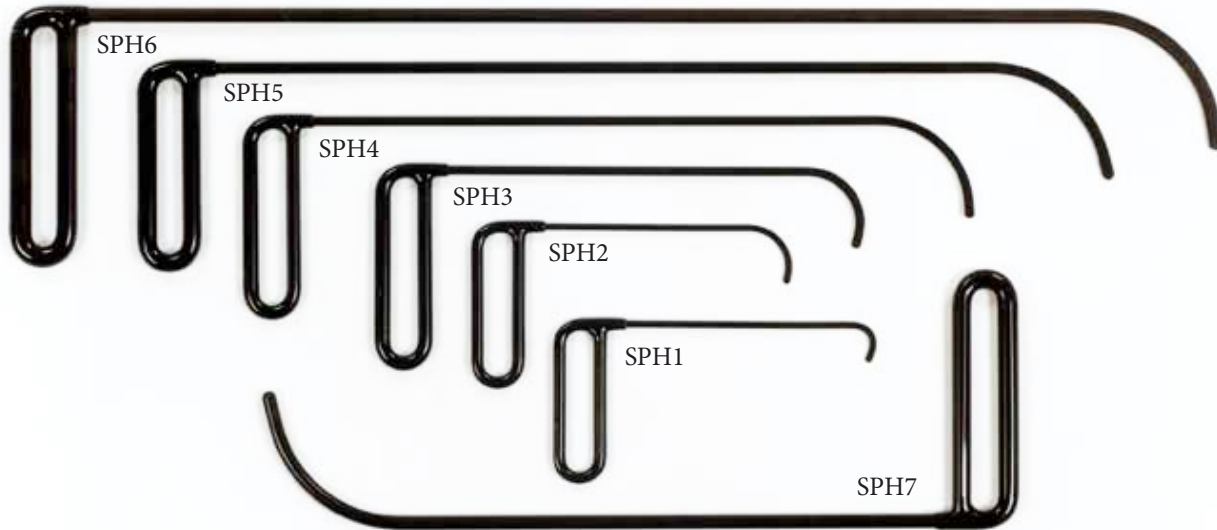

SPH1	\$32.95	.183 (3/16) dia x 8" OAL w/ 1" Curve Flag
SPH2	\$32.95	.183 (3/16) dia x 8" OAL w/ 1-1/2" Curve Flag
SPH3	\$32.95	.243 (1/4) dia x 12" OAL w/ 2" Curve Flag
SPH4	\$32.95	.243 (1/4) dia x 18" OAL w/ 2-1/2" Curve Flag
SPH5	\$32.95	.306 (5/16) dia x 24" OAL w/ 3" Curve Flag
SPH6	\$32.95	.362 (3/8) dia x 30" OAL w/ 3-1/2" Curve Flag
SPH7	\$32.95	.362 (3/8) dia x 18" OAL w/ 3-1/2" Curve Ball End

7pc Side Panel Hook Set

SPHST
\$179.95

Sharp Side Panel Hooks

6pc Sharp Side Panel Hook Set

PSPST
\$159.95

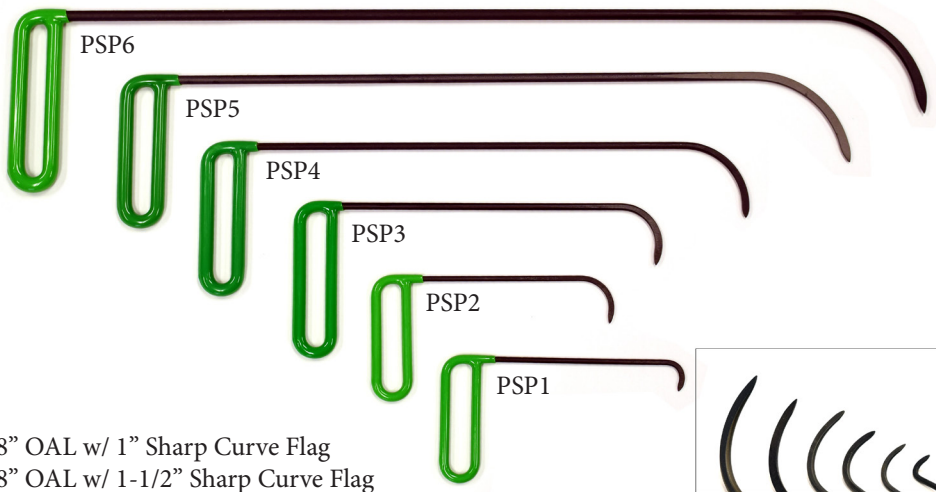

PSP1	\$32.95	.183 (3/16) dia x 8" OAL w/ 1" Sharp Curve Flag
PSP2	\$32.95	.183 (3/16) dia x 8" OAL w/ 1-1/2" Sharp Curve Flag
PSP3	\$32.95	.243 (1/4) dia x 12" OAL w/ 2" Sharp Curve Flag
PSP4	\$32.95	.243 (1/4) dia x 18" OAL w/ 2-1/2" Sharp Curve Flag
PSP5	\$32.95	.306 (5/16) dia x 24" OAL w/ 3" Sharp Curve Flag
PSP6	\$32.95	.362 (3/8) dia x 30" OAL w/ 3-1/2" Sharp Curve Flag

Door Tools

These door tools are ideal for working from the top of doors. The handles are left and right specific at 78 degrees to allow greater strength and control. The flags are forward reach 20 degrees and backward reach 20 degrees in both 3 1/2" and 5" lengths. The overall length of the shaft is 22". The larger 5" flag also has a larger handle.

4pc Set 5" Flags

DTST5

\$114.95

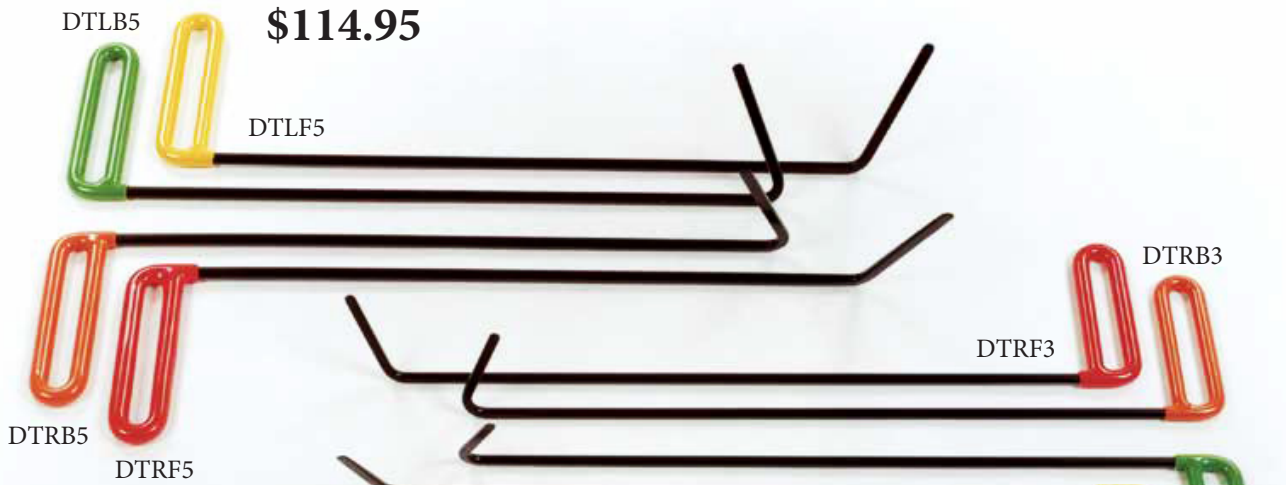

8pc Door Tool Set

5" & 3-1/2"

DTST8

\$229.95

4pc Set 3-1/2" Flags

DTST3

\$114.95

DTLB3
DTLF3

DTLF5	\$34.95	.362 (3/8) dia. x 22" OAL w/ Left Forward 5" Flag
DTRF5	\$34.95	.362 (3/8) dia. x 22" OAL w/ Right Forward 5" Flag
DTLB5	\$34.95	.362 (3/8) dia. x 22" OAL w/ Left Back 5" Flag
DTRB5	\$34.95	.362 (3/8) dia. x 22" OAL w/ Right Back 5" Flag
DTLF3	\$34.95	.306 (5/16) dia. x 22" OAL w/ Left Forward 3-1/2" Flag
DTRF3	\$34.95	.306 (5/16) dia. x 22" OAL w/ Right Forward 3-1/2" Flag
DTLB3	\$34.95	.306 (5/16) dia. x 22" OAL w/ Left Back 3-1/2" Flag
DTRB3	\$34.95	.306 (5/16) dia. x 22" OAL w/ Right Back 3-1/2" Flag

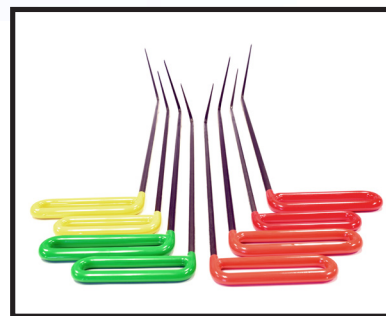

4pc Door Tool Set

(Non Left & Right)

DTST4

\$114.95

DTB5	\$34.95	.362 (3/8) dia. x 22" OAL w/ Back 5" Flag
DTF5	\$34.95	.362 (3/8) dia. x 22" OAL w/ Forward 5" Flag
DTB3	\$34.95	.306 (5/16) dia. x 22" OAL w/ Back 3-1/2" Flag
DTF3	\$34.95	.306 (5/16) dia. x 22" OAL w/ Forward 3-1/2" Flag

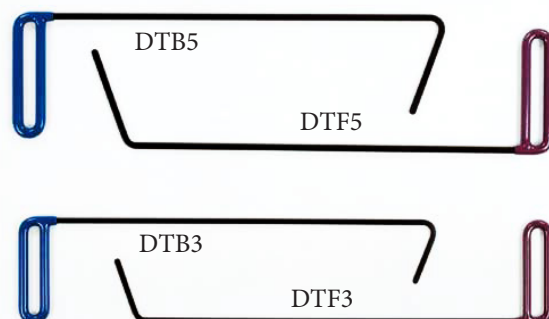

Shaved Tools

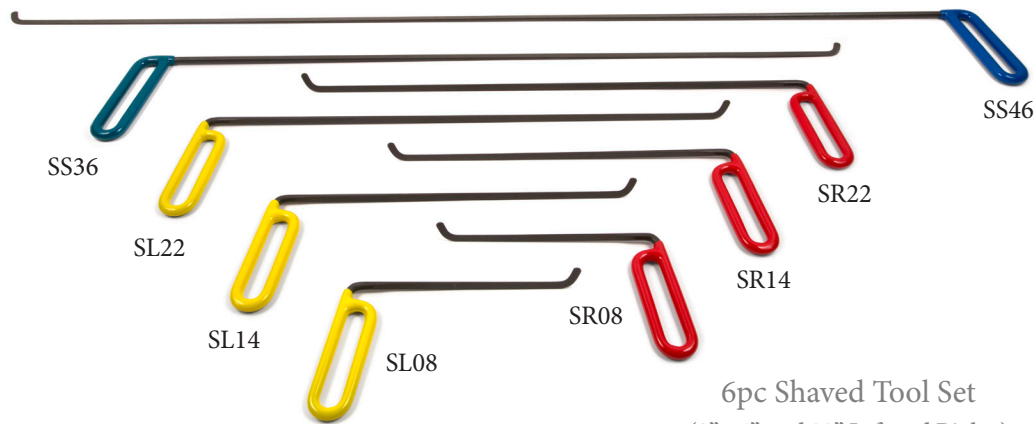

SL08	\$64.95	.306 (5/16) dia. x 8" Left
SR08	\$64.95	.306 (5/16) dia. x 8" Right
SL14	\$64.95	.306 (5/16) dia. x 14" Left
SR14	\$64.95	.306 (5/16) dia. x 14" Right
SL22	\$64.95	.306 (5/16) dia. x 22" Left
SR22	\$64.95	.306 (5/16) dia. x 22" Right
SS32	\$79.95	.306 (5/16) dia. x 32" Straight
SS46	\$79.95	.306 (5/16) dia. x 46" Straight

6pc Shaved Tool Set
(8", 14", and 22" Left and Rights)

STT6
\$295.00

8pc Shaved Tool Set
(All 8 Shaved Tools)

STT8
\$395.00

HANDLES - The shaved tool handle colors are color specific by left (yellow) and right (red) handed tools in the 8", 14" and 22" lengths. The 32" and 46" handles are color specific by length of the tool and is not left or right hand specific. All shaved tool handle lengths are 5". On the 8", 14", and 22", the handles have a 1/2" separation between the handle and the shaft, and on the 32" and 46" there is no separation between the handle and the shaft.

FLAGS - The length of the flag on all of the shaved tools is 7/8" and are set at a 70 degree angle. The thickness of the flag on the 8", 14", and 22" is .045" and the thickness of the flag on the 32" and 46" is .055".

SHAFT - The thickness of the shaft on the 8", 14", and 22" is .306" near the handle and is shaved down to .045" near the flag. The thickness of the shaft on the 32" and 46" is .306" near the handle and is shaved down to .055" near the flag. There is a 25 degree bias on the 8", 14", and 22" and a 0 degree bias on the 32" and 46".

Door Hooks

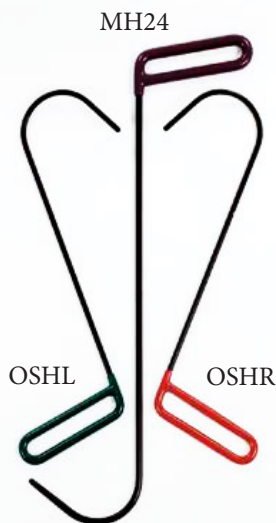

3pc Door Hook Set
(MH24, OSHL, OSHR)

DOORHK
\$154.95

2pc Offset Hook Set
(OSHL & OSHR)

OSHST
\$99.95

MH24	\$64.95	.306 (5/16) dia. x 24" Medium Hook
OSHR	\$54.95	.243 (1/4) dia. x 16" Offset Hook Right
OSHL	\$54.95	.243 (1/4) dia. x 16" Offset Hook Left

(These 3 hooks are a must for door tops. Includes: 1 Left and 1 Right Offset Hook, and 1 Marquise Hook)

Long Flag Tools



2pc Long Flag Set
FLAGST
\$59.95

LF04	\$32.95	.243 (1/4) dia. x 24" w/ 4" Flag
LF06	\$32.95	.306 (5/16) dia. x 24" w/ 6" Flag

Hand Tools and Pick Tools



8pc Hand Tool Set
HTSET
\$149.95

Hand Tools

HTFCL	\$26.95	6" Hand Tool w/ Flat Tip
HTCV	\$26.95	6" Hand Tool w/ Curved Tip
HTBL	\$26.95	6" Hand Tool w/ Blunt Tip
HT12	\$16.95	1/2" Hand Tool
HT01	\$16.95	1" Hand Tool
HT02	\$26.95	2" Hand Tool
HT03	\$26.95	3" Hand Tool
HT04	\$26.95	4" Hand Tool

Our Hand Tools are made of high carbon tempered steel specifically tempered for PDR use. There is a 3/4" offset before the 90-degree bend to allow better access in bracing. The larger 6 have round, cushioned handles for comfort, power, and control.

T-Handle Tools

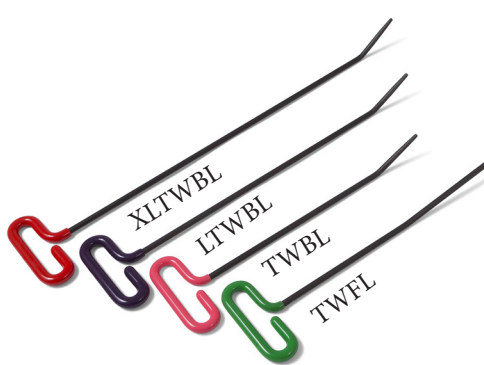

TWFL	\$24.95	.243 (1/4) dia. x 14" Flat Tip
TWBL	\$24.95	.243 (1/4) dia. x 14" Blunt Tip
LTWBL	\$32.95	.243 (1/4) dia. x 17" Blunt Tip
XLTWBL	\$32.95	.243 (1/4) dia. x 21" Blunt Tip

Wire Hand Tools

6pc Set
(HTL2 - HTL7)
HTLST6
\$99.95

HTL2	\$19.95	.243 (1/4) dia. x 2"
HTL3	\$19.95	.243 (1/4) dia. x 3"
HTL4	\$19.95	.243 (1/4) dia. x 4"
HTL5	\$19.95	.243 (1/4) dia. x 5"
HTL6	\$19.95	.243 (1/4) dia. x 6"
HTL7	\$19.95	.243 (1/4) dia. x 7"

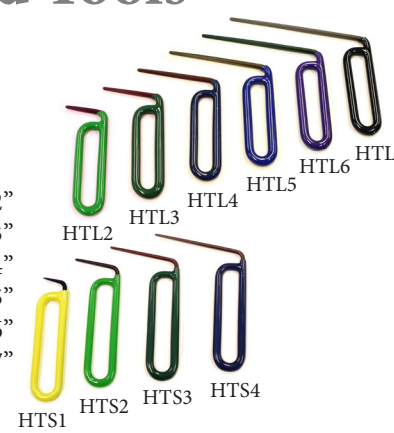

HTS1	\$19.95	.183 (3/16) dia. x 1"
HTS2	\$19.95	.183 (3/16) dia. x 2"
HTS3	\$19.95	.183 (3/16) dia. x 3"
HTS4	\$19.95	.183 (3/16) dia. x 4"

4pc Set
(HTS1 - HTS4)
HTST4
\$69.95

Pick Tools

4pc Pick Set
PCKST
\$249.95



PCK30	\$79.95	.438 (7/16) dia. x 30"
PCK24	\$69.95	.362 (3/8) dia. x 24"
PCK18	\$64.95	.306 (5/16) dia. x 18"
PCK14	\$59.95	.243 (1/4) dia. x 14"

Wire Tools

INDIVIDUAL WIRE PRICES

W984	\$40.95	.362 (3/8) dia. x 84"
W884	\$40.95	.306 (5/16) dia. x 84"
W784	\$40.95	.243 (1/4) dia. x 84"
W972	\$36.95	.362 (3/8) dia. x 72"
W872	\$36.95	.306 (5/16) dia. x 72"
W772	\$36.95	.243 (1/4) dia. x 72"
W960	\$32.95	.362 (3/8) dia. x 60"
W860	\$32.95	.306 (5/16) dia. x 60"
W760	\$32.95	.243 (1/4) dia. x 60"
W948	\$26.95	.362 (3/8) dia. x 48"
W848	\$26.95	.306 (5/16) dia. x 48"
W748	\$26.95	.243 (1/4) dia. x 48"
W648	\$26.95	.183 (3/16) dia. x 48"
W548	\$26.95	.148 (2.5/16) dia. x 48"
W836	\$26.95	.306 (5/16) dia. x 36"
W736	\$26.95	.243 (1/4) dia. x 36"
W636	\$26.95	.183 (3/16) dia. x 36"
W536	\$26.95	.150 (2.5/16) dia. x 36"
W436	\$26.95	.125 (1/8) dia. x 36"
W336	\$26.95	.105 dia. x 36"
W724	\$26.95	.243 (1/4) dia. x 24"
W624	\$26.95	.183 (3/16) dia. x 24"
W524	\$26.95	.148 (2.5/16) dia. x 24"
W424	\$26.95	.125 (1/8) dia. x 24"
W324	\$26.95	.105 dia. x 24"
W224	\$26.95	.090 dia. x 24"
W616	\$26.95	.183 (3/16) dia. x 16"
W516	\$26.95	.148 (2.5/16) dia. x 16"
W416	\$26.95	.125 (1/8) dia. x 16"
W316	\$26.95	.105 dia. x 16"
W216	\$26.95	.090 dia. x 16"
W116	\$26.95	.075 dia. x 16"
W508	\$26.95	.148 (2.5/16) dia. x 8"
W408	\$26.95	.125 (1/8) dia. x 8"
W308	\$26.95	.105 dia. x 8"
W208	\$26.95	.090 dia. x 8"
W108	\$26.95	.075 dia. x 8"

MIX & MATCH

1-2 Wires = Individual Price
 3-5 Wires = 15% off Individual Price
 6-9 Wires = 20% off Individual Price
 10+ Wires = 25% off Individual Price

(Mix & Match includes all Wires)
 (Discount is based on individual tool prices, not set price)

Wire Set Prices		
Complete Wire Set	\$799.95	37Pc
Wire Set A	\$564.95	4' and Under Wires
Wire Set B	\$249.95	Long Wires (5', 6', 7')
Wire Set C	\$199.95	Small Diameter Wires
Wire Set 1	\$109.95	5pc 8" Wires
Wire Set 2	\$124.95	6pc 16" Wires
Wire Set 3	\$124.95	6pc 24" Wires
Wire Set 4	\$124.95	6pc 36" Wires
Wire Set 5	\$109.95	5pc 48" Wires
Wire Set 6	\$82.95	3pc 60" Wires
Wire Set 7	\$92.95	3pc 72" Wires
Wire Set 8	\$102.95	3pc 84" Wires

Wire Set A - 28pc	\$564.95	All 48" and shorter wires
Wire Set B - 9pc	\$249.95	All long wires 60", 72", 84"
Wire Set C - 9pc	\$199.95	All wires below red line

Wire Tool Sizes and Sets										
Set #		8	7	6	5	4	3	2	1	
		3pc	3pc	3pc	5pc	6pc	6pc	6pc	5pc	
Wire Diameter		Lengths								
W9	.362 (3/8)	84"	72"	60"	48"					
W8	.306 (5/16)	84"	72"	60"	48"	36"				
W7	.243 (1/4)	84"	72"	60"	48"	36"	24"			
W6	.183 (3/16)				48"	36"	24"	16"		
W5	.150 (2.5/16)				48"	36"	24"	16"	8"	
W4	.125 (1/8)					36"	24"	16"	8"	
W3	.105					36"	24"	16"	8"	
W2	.090						24"	16"	8"	
W1	.075							16"	8"	

DentGear Tools by Dentcraft

DentGear Saber Tip



DGSB30	\$59.95	.362 (3/8) dia. x 30" Double Bend
DGSB24	\$59.95	.362 (3/8) dia. x 24" Double Bend
DGSB18	\$59.95	.362 (3/8) dia. x 18" Double Bend

DentGear Hook



DGHK30	\$59.95	.306 (5/16) dia. x 30" Shaved Hook
DGHK24	\$59.95	.306 (5/16) dia. x 24" Shaved Hook
DGHK18	\$59.95	.306 (5/16) dia. x 18" Shaved Hook

DentGear Excalibur



DGXC48	\$99.95	.362 (3/8) dia. x 48" Shaved Single Bend
DGXC36	\$89.95	.362 (3/8) dia. x 36" Shaved Single Bend
DGXC24	\$79.95	.362 (3/8) dia. x 24" Shaved Single Bend

DentGear Shaved Wire



DGW36	\$54.95	.243 (1/4) dia. x 36" Shaved Single Bend
DGW30	\$49.95	.243 (1/4) dia. x 30" Shaved Single Bend
DGW24	\$44.95	.243 (1/4) dia. x 24" Shaved Single Bend
DGW18	\$39.95	.243 (1/4) dia. x 18" Shaved Single Bend

Flat Bars

(All Flat Bars have a Thickness of .1875 (3/16))



FBI	\$99.95	1.5" Wide x 22.5" Long w/ Interchangeable Tip
FB22	\$79.95	1" Wide x 22" Long
FBDT	\$99.95	1" Wide x 22" Long
FBW19	\$79.95	1.5" Wide x 19" Long

DentGear Tools and Flat Bars manufactured by Dentcraft are industrial chromed and have a lifetime warranty for the tool. Chrome plating will experience defects from wear and tear, and is not considered a warranty issue.

Interchangeable Tip Rods

Additional tips located on pages 25-27

Interchangeable Tip Hail Rods

Comes Standard with R4 and H24 Tips

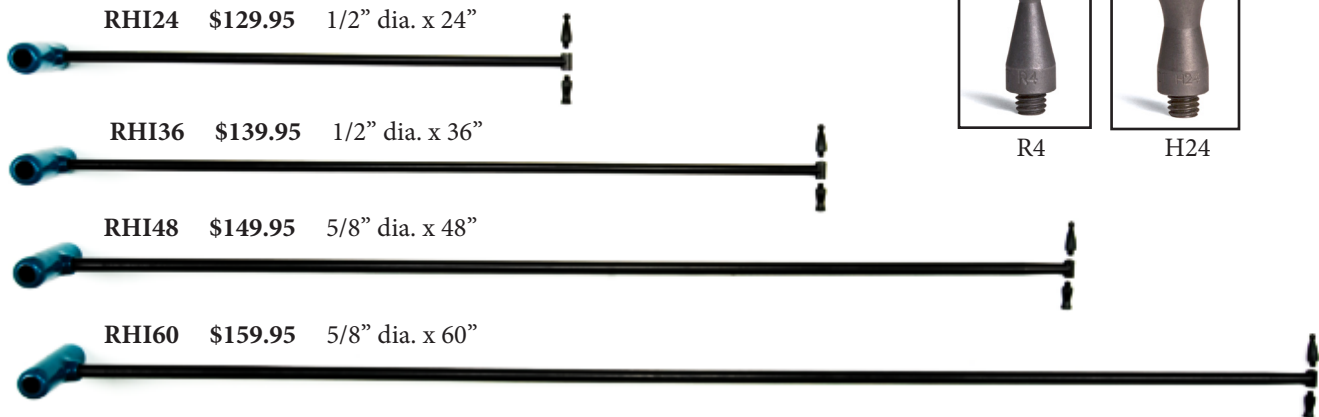

Interchangeable Tip Double Bend Rods

Comes Standard with R4 Tip

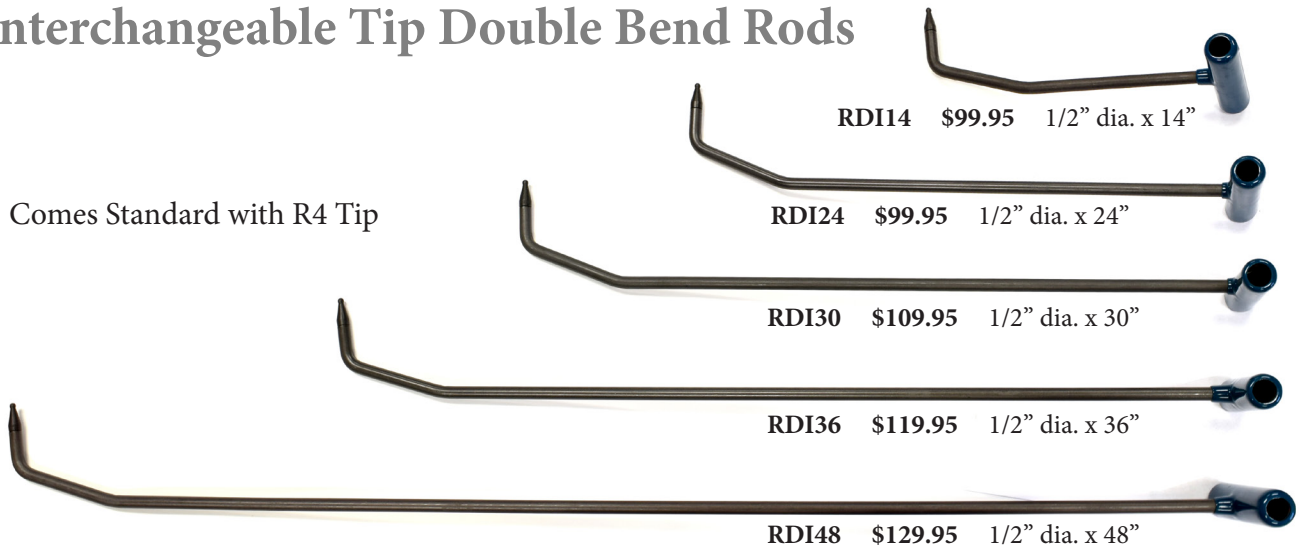

Interchangeable Tip Single Bend Rods

Comes Standard with R4 Tip

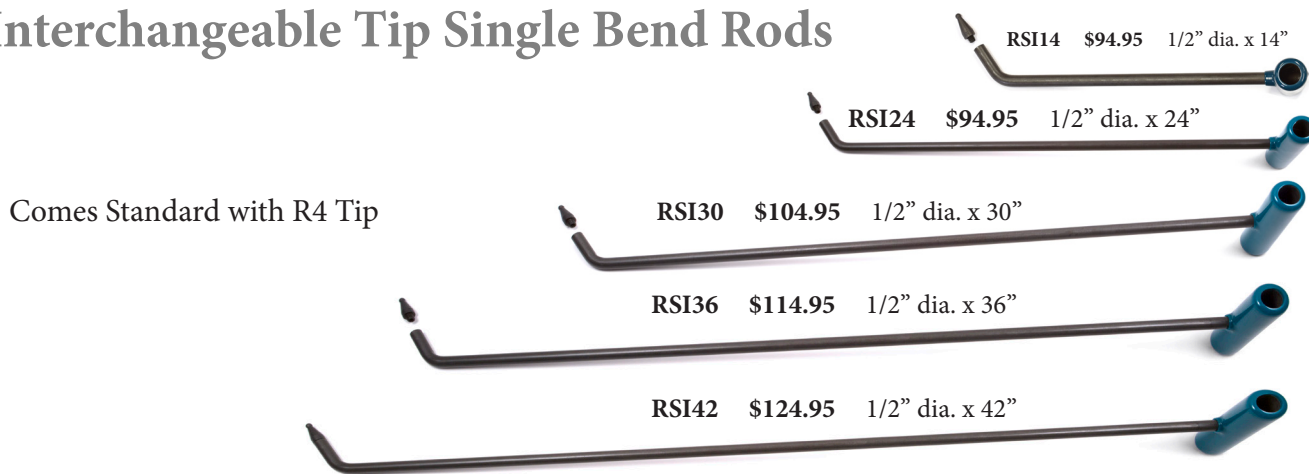

Collapsible Rod Set

w/ Interchangeable Tips

These rugged, yet collapsible rods make traveling much easier.

3 Year Warranty!

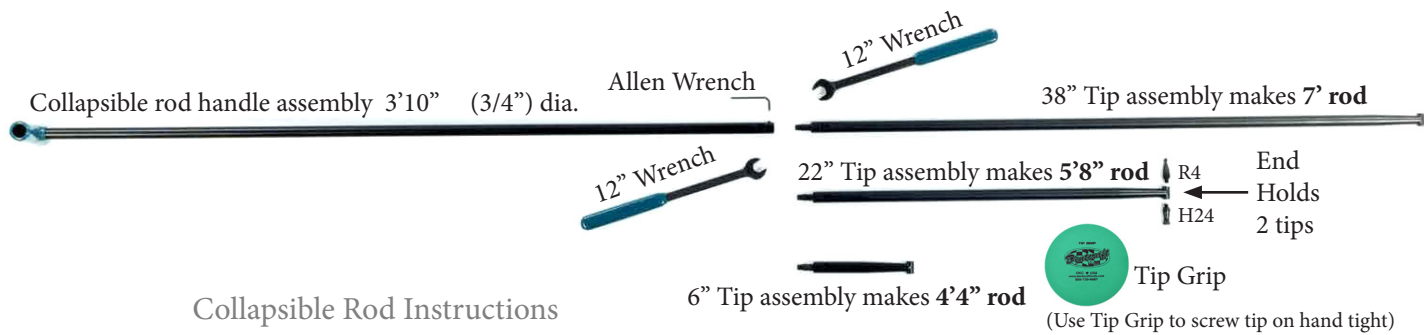

Collapsible Rod Instructions

1. Thread rod combination of choice together by hand until snug.
2. With wrenches provided, tighten until marks align (approx. 30lbs of force)
DO NOT OVERTIGHTEN!

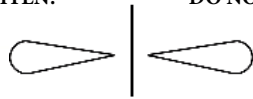

3. With allen wrench provided, tighten and screw. **DO NOT OVERTIGHTEN!**

8pc Set
CRSET
\$395.00

Additional tips located on pages 25-27

Total lengths longer than 7' are NOT recommended due to strength reduction

Accessories for Collapsible Rod Set

CRHA \$74.95 Handle Assembly



CRX8 \$69.95 8" Extension



CRTA6 \$74.95 6" Tip Assembly



CRX16 \$74.95 16" Extension



CRTAST \$64.95 6" Straight Tip Assembly



(6" straight tip assembly end works only with ball tips)

12WST \$25.90 12" Wrench Set (2pc)



AW125

\$0.25
Allen Wrench













TGRIP
\$0.25
Tip Grip

Complete Tip Set
 (Set includes all tips on pages 25 & 26 only)

\$624.95



 Bzero \$7.95	 B1 \$7.95	 B2 \$7.95	 B3 \$7.95	 B4 \$7.95
 B1-P \$6.95	 B2-P \$6.95	 B3-P \$6.95	 B4-P \$6.95	
		 B3-R \$8.95	 B4-R \$8.95	

Working Diameter is the diameter at the working area of the tip, expressed in sixteenths of an inch.

Interchangeable Tips

Thread Count Is 5/16-18

These interchangeable tips will allow you to select the most appropriate tip to match the type of damage and auto being worked. Hard, jagged hail might require a smaller tip than slushy hail. Plastic tips can help minimize scratches on the back of panels. Mushroom tips can push up large areas.





























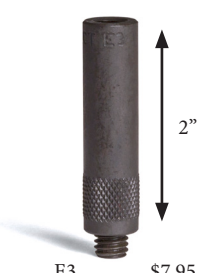

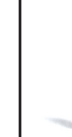

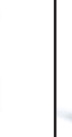



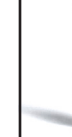





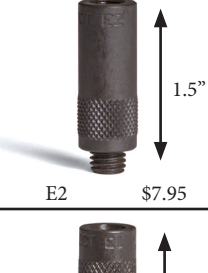







































	STYLE OF TIP	WORKING DIAMETER	FINISH
B	12		
H	24	P	
R	8	R	
M	32	B	

Finish (unmarked is tempered steel)
 P Plastic Version
 R Steel Coated in a hard **RED** PVC
 B Steel Coated in a soft **BLUE** PVC

Style of Tip
 B Bullet Tip
 H Half Inch
 R Round (Ball Tip)
 M Mushroom
 E Extension

Plastic tips are very slick; scuffing the tips help, if using with rod. Polish for use with knockdowns or knockdown hammers.

 R2 \$7.95	 R3 \$7.95	 R4 \$7.95	 R5 \$7.95
 S4 + Tips \$8.95			
		 R4-R \$8.95	 R5-R \$8.95
		 R4-B \$8.95	 R5-B \$8.95

 B6 \$7.95	 B8 \$7.95	 B12 \$7.95	 B16 \$7.95	 B24 \$7.95	 B32 \$7.95				
 B6-P \$6.95	 B8-P \$6.95	 B12-P \$6.95	 B16-P \$6.95	 B24-P \$6.95	 B32-P \$6.95				
 B6-R \$8.95	 B8-R \$8.95	 B12-R \$8.95	 B16-R \$8.95	 B24-R \$8.95	 B32-R \$8.95				
 E3 \$7.95	 H12 \$7.95	 H16 \$7.95	 H24 \$7.95	 H32 \$7.95	 H48 \$7.95	 H64 \$7.95	 H96 \$7.95		
	 H12-P \$6.95	 H16-P \$6.95	 H24-P \$6.95	 H32-P \$6.95	 H48-P \$6.95	 H64-P \$6.95	 H96-P \$6.95		
 E2 \$7.95	 H12-R \$8.95	 H16-R \$8.95	 H24-R \$8.95	 H32-R \$8.95	 H48-R \$8.95	 H64-R \$8.95	 H96-R \$8.95		
	 H12-B \$8.95	 H16-B \$8.95	 H24-B \$8.95	 H32-B \$8.95	 H48-B \$8.95	 H64-B \$8.95	 H96-B \$8.95		
 E1 \$7.95	 R6 \$7.95	 R8 \$7.95	 R12 \$9.95	 R16 \$9.95	 M24 \$9.95	 M32 \$9.95	 M48 \$9.95	 M64 \$9.95	 M96 \$9.95
	 R8-P \$6.95	 R12-P \$8.95	 R16-P \$8.95	 M24-P \$8.95	 M32-P \$8.95	 M48-P \$8.95	 M64-P \$8.95	 M96-P \$8.95	
 R6-R \$8.95	 R8-R \$8.95	 R12-R \$10.95	 R16-R \$10.95	 M24-R \$10.95	 M32-R \$10.95	 M48-R \$10.95	 M64-R \$10.95	 M96-R \$10.95	
 R6-B \$8.95	 R8-B \$8.95	 R12-B \$10.95	 R16-B \$10.95	 M24-B \$10.95	 M32-B \$10.95	 M48-B \$10.95	 M64-B \$10.95	 M96-B \$10.95	



Dentcraft Tools OKC USA

Aluminum Tip Holder
(Holds up to 20 Tips)

TIPH-ALM
\$9.95

Interchangeable Tip Knock Downs and Interchangeable Tips

AKDL \$24.95 4" Aluminum Knock Down w/Tip - 4-3/4" Overall
AKDS \$24.95 3" Aluminum Knock Down w/Tip - 3-3/4" Overall



AKDL -
AKDS -

Aluminum Knock Downs

Aluminum knock downs with interchangeable tips allow you to create the ideal knock down for the type of work being done. Both the long (4-3/4") and short (3-3/4") knock downs come standard with the B4-P tip, unless otherwise requested. You may swap for any tip that Dentcraft manufactures (excluding polished blending tips) at no additional charge. Swapping for a polished blending tip will add an additional charge.

- aluminum - lightweight, yet rigid
- hollow shaft
- button top strike head
- hexagonal outer ring to roll less
- knurled rings for easy grip
- over 100 different tips to choose from (p.25-27)

Steel Knock Downs



STKDL 109 grams / 3.84 ounces



STKDS 84 grams / 2.95 ounces

STKDL \$24.95 4" Steel Knock Down w/Tip - 4-3/4" OAL
STKDS \$24.95 3" Steel Knock Down w/Tip - 3-3/4" OAL

- solid steel throughout
- accepts all standard interchangeable tips (p.25-27)

Peek Interchangeable Tips



PE-B1 \$10.95 **PE-B2 \$10.95** **PE-B3 \$10.95** **PE-B4 \$10.95**



PE-H12 \$10.95 **PE-H24 \$10.95** **PE-H96 \$10.95** **PE-R8 \$10.95**

Leather Padded Blending Tip by CroCarb



L-TIP
\$29.95

Rubber Non Slip Ball Tips



DGR-1
\$9.95



DGR-15
\$12.95

Mirror Polished Tips

Mushroom (M) Polished Tips



M24-PT \$24.95 **M48-PT \$24.95** **M96-PT \$24.95**

3pc (M) Polished Set

MPT-SET \$69.95

Half (H) Polished Tips



H12-PT \$19.95 **H16-PT \$19.95** **H24-PT \$19.95**

3pc (H) Polished Set

HTIP-SET \$54.95

Ultem Interchangeable Tips



B1-ULT \$7.95 **B2-ULT \$7.95** **B4-ULT \$7.95** **B8-ULT \$7.95** **B32-ULT \$7.95**

Knock Down Hammers



3pc Knock Down Hammer Set

KDHST
\$139.95

Large 1-1/2" strike face

- a hammer built specifically for the PDR industry
- all aluminum and very light weight
- multi-use tool with a strike face on one side and an interchangeable tip on the other
- use any of the interchangeable tips (p.25-27) to make it ideal for the particular job
- the longer KDH22 and KDH32 can be used to reach difficult areas as a knock down, or put on a mushroom tip and directly work larger high areas
- smooth contours and grip to minimize scratching
- when used with Dentcraft Tools aluminum knockdowns, a tech can stay focused on the dent area, and easily strike the knock down

Double Tipped Knock Down Hammers

- same lengths and weights as original knock down hammer set
- detachable large 1-1/2" strike face lets the tech now be able to use an interchangeable tip (p.25-27) on each side of the hammer
- DTKDH12 and DTKDH22 comes standard with detachable strike face and B4-P tip, DTKDH32 comes standard with detachable strike face and M96-B tip
- swap the standard interchangeable tip and/or detachable strike face with any interchangeable tip that Dentcraft manufactures (p.25-27) at no additional charge (excluding mirror polished tips, mirror polished tips can be swapped for an additional charge)



3pc Double Tip Knock Down Hammer Set

Large 1-1/2" detachable strike face

DTKDHST
\$149.95

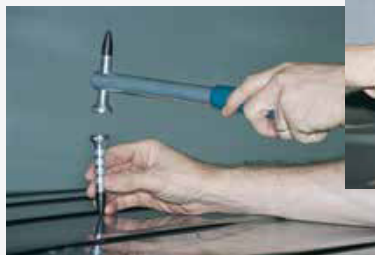

Light hammer with knock down



Medium reach knock down



Long reach knock down



Use with padded tips for large high spots or "eye brows"

Indexable Handle Tools

Some of Dentcraft's best selling PDR Tools are now available with adjustable handles. Adjustable Dent Tools allow the PDR Technician to arrange the handle in various positions for comfort and leverage. The new and improved handle takes about **20lbs** of pressure. Handles are adjustable by pushing **DOWN** on the handle.



Handle rotates 360°

Indexable Double Bend Wires

NXW948	\$64.95	.362 (3/8) dia. x 48"
NXW848	\$64.95	.306 (5/16) dia. x 48"
NXW936	\$64.95	.362 (3/8) dia. x 36"
NXW836	\$64.95	.306 (5/16) dia. x 36"
NXW924	\$64.95	.362 (3/8) dia. x 24"
NXW824	\$64.95	.306 (5/16) dia. x 24"

Double Bend Wires w/ Sharp Tips

2-1/2"
70° Bend
15° Bend
4"

Indexable Rods

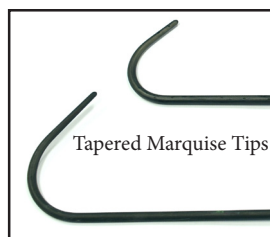
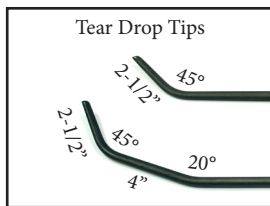

NXRS30	\$129.95	.362 (3/8) dia. x 30"
NXRD30	\$134.95	.362 (3/8) dia. x 30"
NXRSH24	\$129.95	.306 (5/16) dia. x 24"
NXMH24	\$94.95	.306 (5/16) dia. x 24"

Indexable Handle Tools

Indexable Side Panel Hooks

NXSPH8	\$64.95	.362 (3/8) dia. x 42" OAL
NXSPH6	\$64.95	.362 (3/8) dia. x 30" OAL
NXSPH5	\$64.95	.306 (5/16) dia. x 21" OAL
NXSPH7	\$64.95	.362 (3/8) dia. x 18" OAL

Sharp Tip Indexable Side Panel Hooks

NXPSP6	\$64.95	.362 (3/8) dia. x 30" OAL
NXPSP17	\$64.95	.362 (3/8) dia. x 17" OAL
NXPSP7	\$64.95	.362 (3/8) dia. x 18" OAL

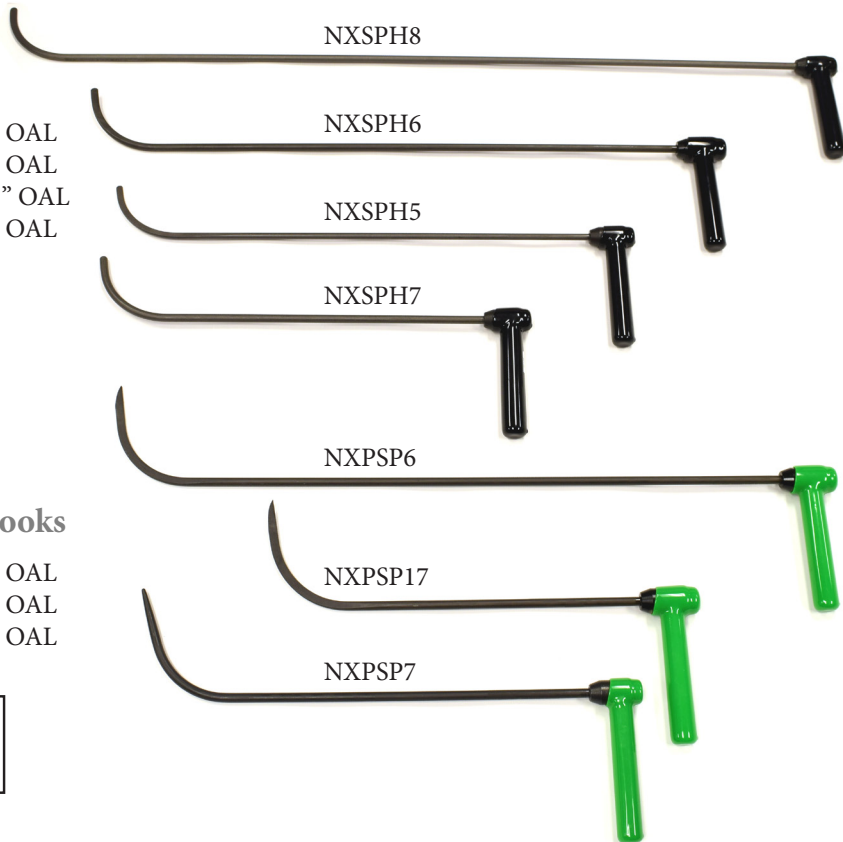
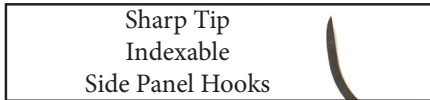

Indexable Door Tools

NXDF5	\$64.95	.362 (3/8) dia. x 22" OAL w/ 5" Forward Flag
NXDF3	\$64.95	.306 (5/16) dia. x 22" OAL w/ 3-1/2" Forward Flag
NXDB5	\$64.95	.362 (3/8) dia. x 22" OAL w/ 5" Back Flag
NXDB3	\$64.95	.306 (5/16) dia. x 22" OAL w/ 3-1/2" Back Flag
NXLF06	\$64.95	.306 (5/16) dia. x 24" OAL w/ 6" Flag

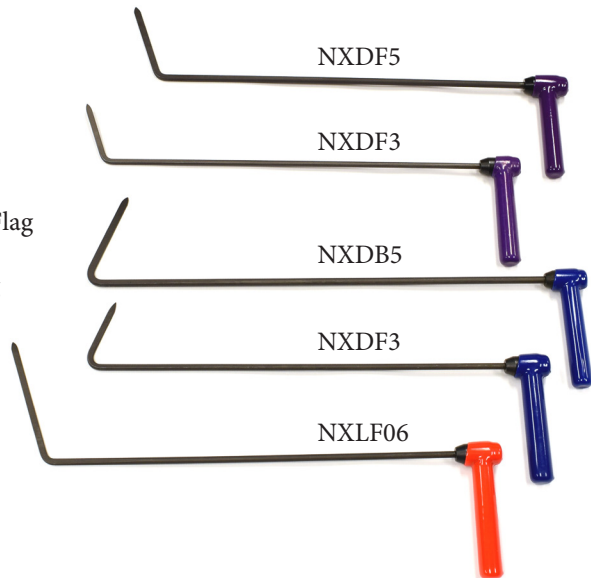
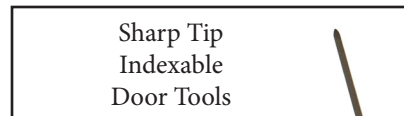

3/8" Rods with Interchangeable Tips

3/8" Single Bend Rods

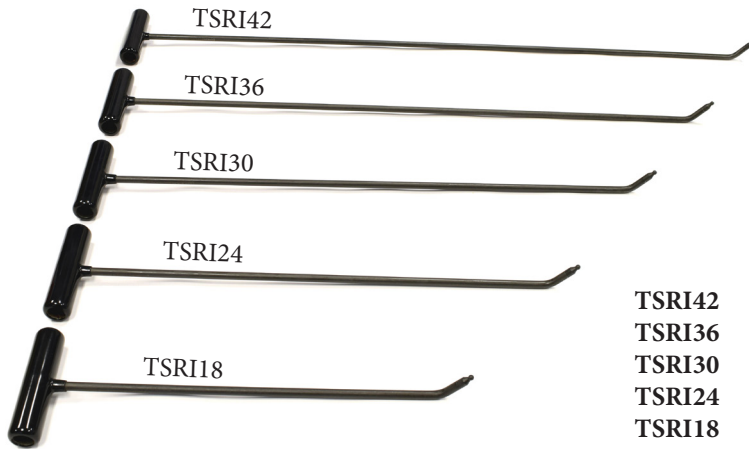

Comes Standard with 38R4 tip

TSRI42	\$119.95	.362 (3/8) dia. x 42"
TSRI36	\$109.95	.362 (3/8) dia. x 36"
TSRI30	\$104.95	.362 (3/8) dia. x 30"
TSRI24	\$94.95	.362 (3/8) dia. x 24"
TSRI18	\$94.95	.362 (3/8) dia. x 18"

Only interchangeable tips & extensions beginning with "38" are compatible with the 3/8 interchangeable tip single bend rods. The "38" interchangeable tips can be located on page 32.

3/8" Double Bend Rods



Comes Standard with 38R4 tip

TDRI42	\$119.95	.362 (3/8) dia. x 42"
TDRI36	\$109.95	.362 (3/8) dia. x 36"
TDRI30	\$104.95	.362 (3/8) dia. x 30"
TDRI24	\$94.95	.362 (3/8) dia. x 24"
TDRI18	\$94.95	.362 (3/8) dia. x 18"

Only interchangeable tips & extensions beginning with "38" are compatible with the 3/8 interchangeable tip double bend rods. The "38" interchangeable tips can be located on page 32.

3/8" Hook Rods

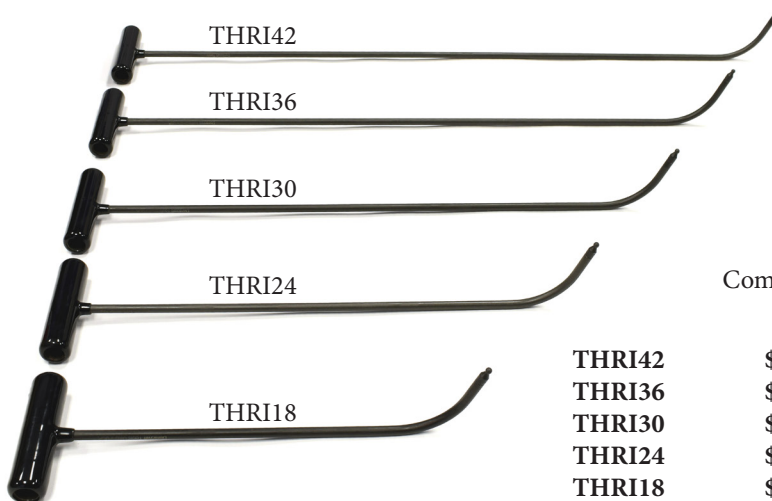

Comes Standard with 38R4 tip

THRI42	\$119.95	.362 (3/8) dia. x 42"
THRI36	\$109.95	.362 (3/8) dia. x 36"
THRI30	\$104.95	.362 (3/8) dia. x 30"
THRI24	\$94.95	.362 (3/8) dia. x 24"
THRI18	\$94.95	.362 (3/8) dia. x 18"

Only interchangeable tips & extensions beginning with "38" are compatible with the 3/8 interchangeable tip hook rods. The "38" interchangeable tips can be located on page 32.

**** Interchangeable Tips on p. 25-26 are NOT compatible with the 3/8 Interchangeable Tip Rods on this page. The 3/8 Interchangeable Rod Tips that are compatible are located on page 32, beginning with "38". ****

3/8" Interchangeable Tips

3/8" Bullet Tips



3/8" Half Tips



3/8" Round (Ball) Tips



3/8" Extensions



3/8" S-Tip



****3/8" Interchangeable Tips are ONLY Compatible with 3/8" Interchangeable Tip Rods located on page 31.****

3/8" Aluminum Tip Holder
(Holds up to 20 3/8" Tips)

38-TIPH
\$9.95



Window Shields and Accessories

5pc Accessory Set

ACCST

\$39.95

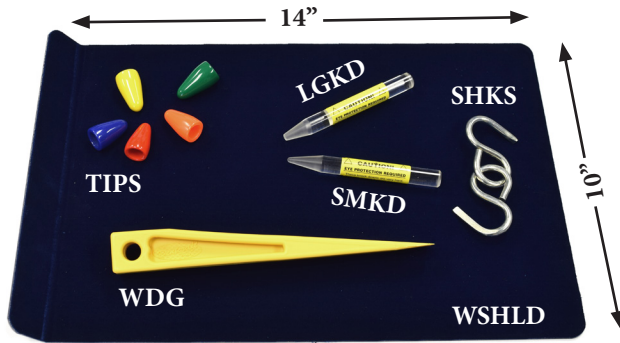

WSHLD	Lexan Window Shield laminated with velvet to protect against scratching the glass	\$19.95
WDG	Window Wedge 9" Long x 1" Wide	\$7.95
LGKD	Large Tip Acrylic Knockdown	\$6.95
SMKD	Small Tip Acrylic Knockdown	\$6.95
SHKS	S-Hooks	\$4.95
TIPS	Tips for Knockdowns	\$0.25 (1pc)

Window Shields

Lexan Window Shields Laminated with velvet to protect against scratching the glass. Flanges are 1-1/2" at a 50° angle.

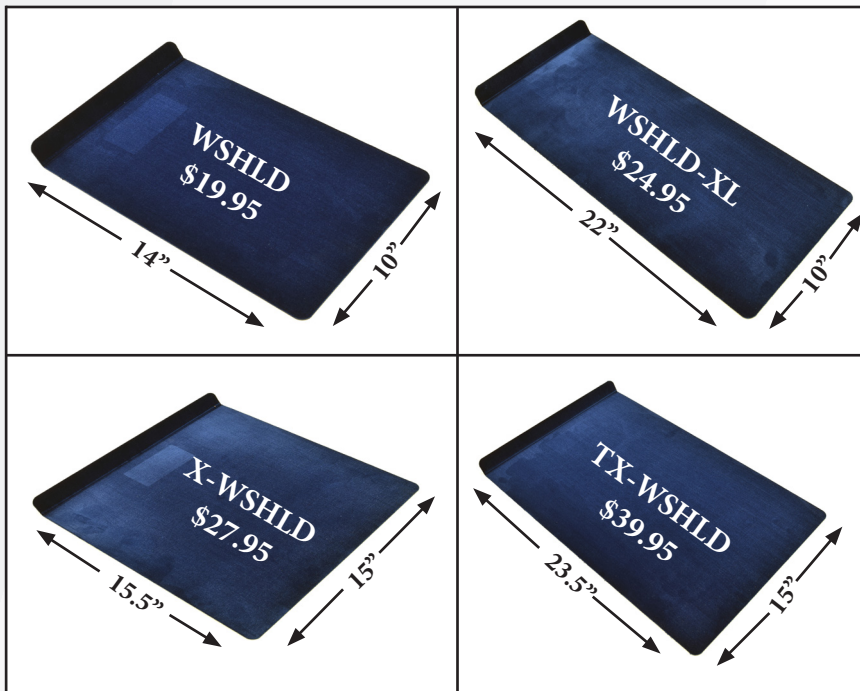

Metal

Window Shields

- Has a mirror finish, designed to see the inside of panels for access points and bracing
- Their functionality will last a long time, although will scratch overtime from continued use. Even with scratches, their reflection is still useful
- Manufactured out of 20 Guage Stainless Steel
- Comes with own carrying bag
- Flanges are 1-1/2" at a 75° angle

Metal Window Shield
M-WSHLD
\$44.95

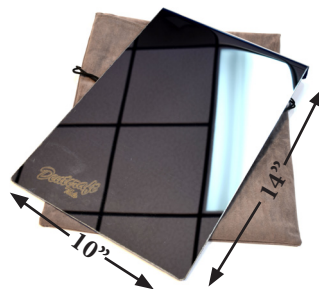

Wide Metal Window Shield
MX-WSHLD
\$69.95

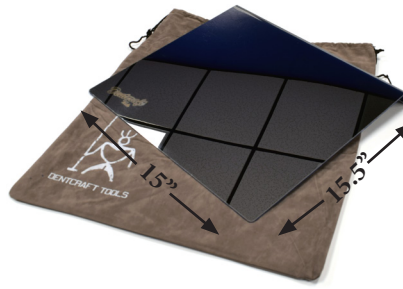

Long Metal Window Shield
LM-WSHLD
\$69.95

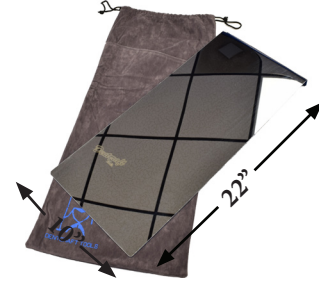

Accessories

3pc Dent Dollies

DNTDL

\$29.95



Red = 12 inch / 30.4cm radius
Yellow = 24 inch / 61cm radius
Blue = No bend / No radius

A simple, but significant tool for dents that overlap the edge of body panels (i.e., roof tops, wheel wells, fender, and quarter tops).

Step 1

Work the dent from underneath as usual until a “plateau” of effectiveness is encountered. (Note: the reason this happens is because the corners are still holding the dent).

Step 2

Use the Dent Dollies to knock down the high spots that are wrapped around the corner, and to release the stresses holding down the “flat spot” (see illustration to the upper right)

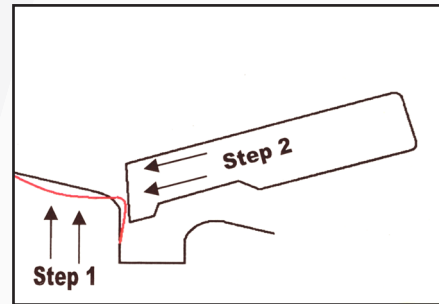

There are three different radii of Dent Dollies to best match the contours of body corners

- Changing the strike angle can change the way and where the metal is raised.
- Start light

Leverage Blocks



BGBLK	\$24.95	Big Leverage Block (2 x 3 x 4)
SMBLK	\$19.95	Small Leverage Block (1-1/2 x 2 x 3)
TBLK	\$18.95	Third Leverage Block
MBLK	\$14.95	Mini Leverage Block

Knockdowns



SMKD	\$6.95	Small Tip Acrylic Knockdown x 4-1/2” Long
LGKD	\$6.95	Large Tip Acrylic Knockdown x 4-1/2” Long
BK-SMKD	\$7.95	Small Tip Delrin Knockdown x 4-1/2” Long
BK-LGKD	\$7.95	Large Tip Delrin Knockdown x 4-1/2” Long
RB-SMKD	\$9.95	Small Tip Ultem Knockdown x 4-1/2” Long
RB-LGKD	\$9.95	Large Tip Ultem Knockdown x 4-1/2” Long
PE-SMKD	\$14.95	Small Tip Peek Knockdown x 4-1/2” Long
PE-LGKD	\$14.95	Large Tip Peek Knockdown x 4-1/2” Long

Red Tips for 1/4 Round Tips

(Cap for R4 tip on p.25 & 38R4 tip on p.32)



R-Tips (1pc) **\$0.25**
R-Tips (100pk) **\$19.95**



Soft Tips for S4 Tips

(Cap for S4 tip on p.25 & 38S4 tip on p.32)



S-Tips (1pc) **\$0.25**
S-Tips (100pk) **\$19.95**



Kwik Bench, Gun Cases, and Bags

With increasing manufacturer costs, prices for accessories may change without notice. Please call, or visit website for most up-to-date pricing.



KWIK BENCH
KWIK
\$359.00

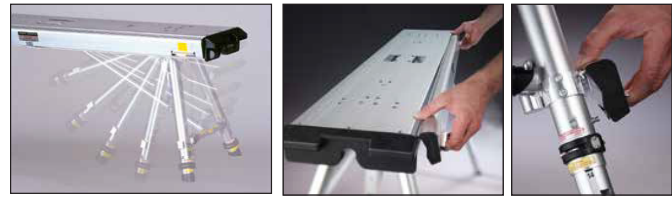

- Erects and folds in seconds
- Adjustable Height 18" - 32"
- Rubber End Bumpers
- Removable Step Rail (stows in bench)
- Compact 3" x 11" x 51"
- Light Weight (all aluminum)



KWIK BENCH
TOOL TRAY
TRAY
\$84.95



52" x 7" x 7" (132cm x 18cm x 18cm)
Dentcraft Rolling Bag
RBAG
\$99.95



SKB Tool Case

SKB
(SKB5014G)
\$289.95

- Gun Case (4 gun)
- Empty weight 25 lbs.
- 50" x 14" with convoluted foam and divider
- Molded in wheels with handle
- Weatherproof
- Airline safe



SKB Watertight Tool Case

DB-SKB
(3i-SKB5014)
\$289.95

- Interior dimension 50.50" x 14.50"
- Empty weight 22lbs.
- Uni-body design to eliminate excessive metal reinforcing hardware for a lighter weight case
- Constructed of ultra-high strength polypropylene copolymer resin
- Gasketed, waterproof, and dustproof, submersible design
- Resistant to UV, solvents, corrosion, fungus, and impact damage (MIL-STD-180F)
- Molded-in hinges with stainless steel hinge pins
- Four patented "trigger release" latches

Lights, Boards, and Carts

(Check website for more lighting, carts, & hood stands)

With increasing manufacturer costs, prices for accessories may change without notice. Please call, or visit website for most up-to-date pricing.



Pro PDR Quick Light 36"

PROQ 36

\$844.00

- 3 LED strips - Warm/Cool/Warm
- Infinite knob based dimmer
- Independent strip control via 3 switches
- Comes with Quick Light 36" WCW + dimmer + LS3FH Stand



Pro PDR Quick Light 46"

PROQ 46

\$869.00

- 3 LED strips - Warm/Cool/Warm
- Infinite knob based dimmer
- Independent strip control via 3 switches
- Comes with Quick Light 46" WCW + dimmer + LS3FH Stand

Elimadent Mini Lights



20"

14"

EL-14-DW	\$300.00	14" 20 volt Dewalt
EL-14-MK	\$300.00	14" 18 volt Makita
EL-20-DW	\$350.00	20" 20 volt Dewalt
EL-20-MK	\$350.00	20" 18 volt Makita

- V2 3 strip mini lights
- Warm/Cold/Warm
- Spinal cord with cover

Battery and Charger Sold Separately

Never Loose Magnetic Light Mounting System

Never Loose

\$267.00



- Great alternative to traditional light collar
- No more worrying about broken studs, balls spinning loose, little articulation, and messing with levers
- Allows 119 lbs. of pulling strength
- Move 180° in all directions
- Spin 360° without ever touching levers
- Real time saver!

Willey Quick Cart

WQ-CART

\$649.00



- 39" total height
- 18" x 18" tray dimensions
- 19 lbs. total weight
- 2 trays, 4 legs, 2 knobs
- Pizza box sized carrying bag

(Check website for more accessories)

Reflector Boards



RBRD-Yellow	\$69.95	6" x 8"
RBRD-White	\$69.95	6" x 8"
RBRD-Grey	\$69.95	6" x 8"
XLRBRD-Yellow	\$74.95	6" x 16"
XLRBRD-White	\$74.95	6" x 16"
XLRBRD-Grey	\$74.95	6" x 16"

(Includes 3" suction cup, locline w/ends)

Extra Boards		
BRD-Yellow	\$14.95	6" x 8"
BRD-White	\$14.95	6" x 8"
BRD-Grey	\$14.95	6" x 8"
XLBRD-Yellow	\$19.95	6" x 16"
XLBRD-White	\$19.95	6" x 16"
XLBRD-Grey	\$19.95	6" x 16"

- 2 sided board (lines to fade and double fade)
- 3" pump suction cup
- Loline with Ends
- 3 colors to choose from (yellow, white, or grey)



Small Suction Cup

SMSUC

\$39.95

(3" Pump up suction cup w/ 1/4-20 post for R-Board)



LOCLN w/ ends

\$16.95

Glue Tabs

With increasing manufacturer costs, prices for accessories may change without notice. Please call, or visit website for most up-to-date pricing.

Black Plague Gang Green Smooth Tabs

(Variety Pack Shown)

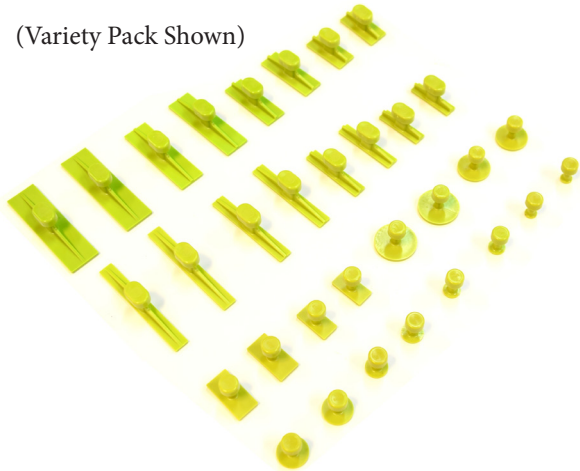

BPGG9	\$29.98 (10pk)	9mm Round
BPGG12	\$29.98 (10pk)	12mm Round
BPGG15	\$29.98 (10pk)	15mm Round
BPGG20	\$29.98 (10pk)	20mm Round
BPGGPK	\$89.00 (32pc)	Variety Pack

Black Plague Smooth Tabs

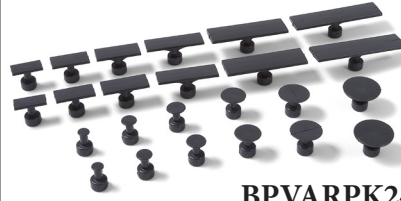

24pc Includes

Round	Crease
2 x 9mm	2 x 26mm
2 x 12mm	2 x 32mm
2 x 15mm	2 x 38mm
2 x 20mm	2 x 51mm
2 x 25mm	2 x 70mm
2 x 30mm	2 x 83mm

BPVARPK24
\$74.12

Dentcraft Purple Tabs

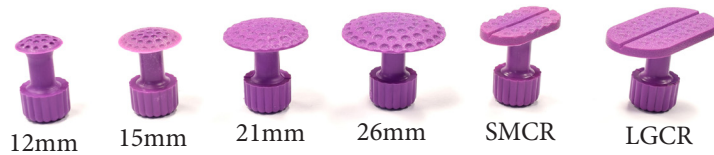

PRP12	\$11.95 (10pk)	12mm Round
PRP15	\$11.95 (10pk)	15mm Round
PRP21	\$11.95 (10pk)	21mm Round
PRP26	\$11.95 (10pk)	26mm Round
PRPSMCR	\$11.95 (10pk)	12mm x 25mm Small Crease
PRSLGCR	\$11.95 (10pk)	17mm x 35mm Large Crease
PRVVPK	\$13.95 (12pc)	2 x Each Size

Gang Green Dead Center 12pk

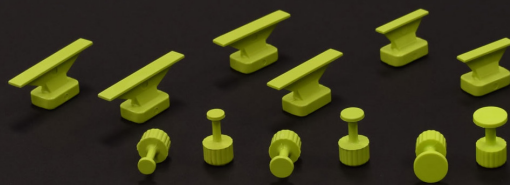

GGDCPK12	\$39.00	2 x 7mm Round	2 x 25mm Crease
		2 x 9mm Round	2 x 38mm Crease
		2 x 13mm Round	2 x 44mm Crease

Gang Green Dead Center 6pk



GGDCPK6	\$18.00	2 x 7mm Round
		2 x 9mm Round
		2 x 13mm Round



Dead Center Ice

DeadCenter 5	\$13.75 (5pk)	5mm Round
DeadCenter 7	\$13.75 (5pk)	7mm Round
DeadCenter 9	\$13.75 (5pk)	9mm Round
DeadCenter 13	\$13.75 (5pk)	13mm Round
DeadCenterVpk	\$49.95 (20pc)	Variety Pack

(Variety Pack Shown)

Glue Tabs and Glue Kits

With increasing manufacturer costs, prices for accessories may change without notice. Please call, or visit website for most up-to-date pricing.

Wurth Red Tabs



16mm	21mm	27mm	32mm
WRed16	\$2.25	16mm Round	
WRed21	\$2.25	21mm Round	
WRed27	\$2.25	27mm Round	
WRed32	\$2.25	32mm Round	
WRPK (4pc)	\$7.95	Variety Pack	

Robo Tabs



9mm	12mm	15mm	SMSQ	LGSQ
Robo9	\$9.95 (5pk)	9mm Round		
Robo12	\$9.95 (5pk)	12mm Round		
Robo15	\$9.95 (5pk)	15mm Round		
RoboSMSQ	\$9.95 (5pk)	Small Square		
RoboLGSQ	\$9.95 (5pk)	Large Square		
RoboVPK	\$19.95 (10pc)	2 x Each Size		

Dentcraft Small Glue Kit DCSM

\$84.95



Includes

- 14 glue sticks (varieties subject to change)
- 31 glue tabs (varieties subject to change)

Red Smooth Crease Tab

By Blehm



BSCT **\$1.50**

MCore Tabs



MC12mm	MC16mm	MC21mm
MC12	\$2.95	12mm Steel Round
MC16	\$2.95	16mm Steel Round
MC21	\$2.95	21mm Steel Round
MCVPK (3pc)	\$7.95	Variety Pack

Dentcraft Large Glue Kit LG-GLUE-KIT

\$349.95



Includes

- DC Small Glue Kit (glue & tab varieties subject to change)
- BDML (Mini Lifter)
- 12vvg (12-volt Glue Gun)
- SLHMR (12oz. Slide Hammer)

Mini Lifters and Slide Hammers

With increasing manufacturer costs, prices for accessories may change without notice. Please call, or visit website for most up-to-date pricing.



Mini Lifter
ML101
\$99.95



BD Mini Lifter
BDML
\$139.95



Keco Robo
Mini Lifter
KecoRobo
\$129.95

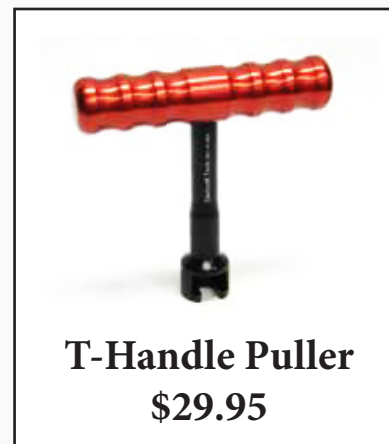

T-Handle Puller
\$29.95



12oz. Slide Hammer
SLHMR
\$149.95

- 12oz. aluminum slide
- Light weight
- Anodized finish steel shaft
- Fits most glue tabs
- 19" overall length



Steel 2lb. Slide Hammer
2lb. SLHMR
\$149.95

Now with Steel Tab Adapter

- 2lb. steel slide
- Weight and steel shaft zinc coated
- Fits most glue tabs
- 19" overall length



Edge Jack by Shane Jacks
E Jack
\$112.95

- Works with Mini Lifters
- Works from the edge of a panel that is doubled or tripled walled
- Works with Interchangeable Tips (on pages 25 & 26)

Glue Guns and Accessories

With increasing manufacturer costs, prices for accessories may change without notice. Please call, or visit website for most up-to-date pricing.

SureBonder Battery Powered Glue Gun

SB-BGG

\$24.95

Battery NOT included and WILL require adapter for Dewalt, Makita, and Milwaukee

SureBonder

- Works with 18v Ryobi Battery right out of the box
- Requires adapter for 20v Dewalt
- Requires adapter for 18v Makita
- Requires adapter for 18v Milwaukee





SB-DWA \$18.95



SB-MKTA \$18.95



SB-MLKW \$18.95

TriFecta Battery Powered Glue Gun

Tri-GG

\$139.95

Battery NOT included and WILL require adapter for Dewalt, Makita, and Milwaukee

TriFecta

- Works with 18v Ryobi Battery right out of the box
- Requires adapter for 20v Dewalt, 18v Makita, & 18v Milwaukee
- Dual temperature design. Red light temperature setting of 383° Farenheit, Blue light, Eco Mode.
- Achieves temperature in 3 minutes





TRI-DWA \$39.95



TRI-MKTA \$39.95



TRI-MLKW \$39.95



SureBonder Cordless Glue Gun

\$16.95



LRG - Glue Gun

\$34.95 (110v - 240v)

Battery Grip Shell by Willey Quick



Batt-Shell

\$11.95

- Fits most Milwaukee, Makita, Dewalt
- Good use to hold glue tabs, nuts, bolts, etc.



12VGG

\$19.95

(12-Volt, 40 watt Glue Gun)



Porter Cable PC Heat Gun

\$36.95

(1500-Watt, Variable Temp. Control)

PDR Glue

With increasing manufacturer costs, prices for accessories may change without notice. Please call, or visit website for most up-to-date pricing.



Tab Weld \$24.95 (10pk)

Pink Glue \$19.95 (10pk)



Green Glue \$19.95 (10pk)



Purple Glue \$19.95 (10pk)



Hawg Glue \$21.95 (10pk)

DentOut



Red Glue \$14.95 (10pk) **Yellow Glue** \$14.95 (10pk)



Black Glue \$13.50 (10pk)



Cam Glue \$20.00 (10pk)



Blue Glue \$19.95 (10pk)



Power Glue \$44.95
30-32 Sticks
2.2 lbs. (1 Kilo)

Magnetic Spray Bottle



Willey Bottle
\$7.00

- Spray Bottle with Magnet
- Sticks to steel panels for close access while you work
- ISO-Alcohol not included

Glue Chart

Tab Weld	High Strength	Warm, Mod., Cool
Pink	High Strength	Mod. to Very Hot
Green	High Strength	Warm, Mod., Cool
Purple	High Strength	Warm, Mod., Cool
Hawg	High Strength	Mod. to Hot
Red	High Strength	Mod. to Hot
Yellow	Med. Strength	Cool to Cold
Black	High Strength	Cool to Warm
Cam	High Strength	All Weather
Blue	High Strength	Use for Large Glue Tab
Power	High Strength	Warm to Hot

****With increasing manufacturer costs, prices for accessories may change without notice. Please call, or visit website for most up-to-date pricing.****

5lb. Slide Hammer ONLY recommended with Super Tabs & Glexo. This is a VERY LARGE Slide Hammer and is NOT designed to be used with smaller tabs.



**5lb. Slide Hammer
SLHMR5
\$149.95**

5lb. Slide Hammer recommended

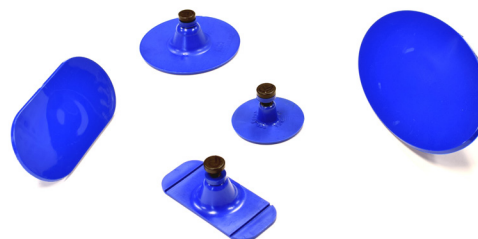

**Keco Super Tabs
STABPK
\$69.95**

GLE XO

Glexo is a cold glue system. A unique adhesion formula allows this very sticky substance to work with hammers and move massive amounts of metal. When finished, re-wrap in the wax paper.

GLE XO Mini 1 x Glexo Cold Glue
\$174.95 2 x Power Tabs

GLE XO Full 1 x Glexo Cold Glue
\$289.95 4 x Power Tabs

GLE XO Hail 2 x Glexo Cold Glue (one for hotter temps)
\$330.00 5 x Glexo Tabs (Various Sizes)

GLE XO Micro
\$330.00

2 x 10mm Tabs
2 x 15mm Tabs
2 x 20mm Tabs
2 x Types of Adhesives

Temp range: 5°F / -15°C to 86°F / 30°C

30 Sticks

GLE XO Hot Melt Glue
\$58.00

Accessories

With increasing manufacturer costs, prices for accessories may change without notice. Please call, or visit website for most up-to-date pricing.



2" Reach

Edge Pliers
BD Pliers
\$195.95



4" Reach

Panel Edge Pliers
Panel Pliers
\$249.95



Hatch Jammer
Hatch
\$29.95



Hatch Jammer XL
Extends up to 59"
\$59.95



Hatch Jammer Extension
\$29.95
For use with Hatch Jammer



Hatch and Quarter
Hanger
HQH
\$34.95



O Ring Remover
17004
\$13.95



Steck
Trim Clip Pliers
21720
\$22.95



Trim Tool Set
Trim Set
\$14.95



Door Upholstery
Remover
35400
\$9.95

Wedges and Accessories

With increasing manufacturer costs, prices for accessories may change without notice. Please call, or visit website for most up-to-date pricing.

Window Wedge
WDG
\$7.95

9"
1.5"

Window Wedge 1.5
WDG M
\$8.95

9"
1.5"

Window Wedge Extra Wide
WDG XW
\$10.95

9"
2"

Inspection Light Wedge
LT WDG
\$29.95

9"
1.25"

Steck Inflatable Wedge
STKWDG
\$24.95

Inflatable Wedge
IWDG
\$14.95

Inflatable Wedge XL
IWDG XL
\$19.95

(Collapsed 14.5", Expands to 23.5")

Aluminum Hood Prop
ALMHP
\$34.95

ALMHP Tips
AHPT
\$2.95
 (2pc)

Lisle Hood Prop
45900
\$39.95

(18-1/2" to 46-3/4")

Steck Door Jammer
17000
\$27.95

B & D Door Jammer
BDDRJ
\$51.95

Hammers and Knock Downs

With increasing manufacturer costs, prices for accessories may change without notice. Please call, or visit website for most up-to-date pricing.

2oz. Blending Hammer
BHMR2
\$22.95



(Comes with 2 Soft Caps)

Large/Small Face Hammer
HMR10
\$29.95



- Large Face 1-1/2" / Small Face 5/8"
- Comes with 3 Soft Tips for Small Face
- Only 10 oz.

Shane Jacks Blending Hammer
JXHMR
\$139.95



- Balanced accurately blending hammer
- 6 oz. with standard tips
- 12.75" length
- Comes with M24 Polished Tip (M24-PT) and B2 Plastic Tip (B2-P)

XL Shane Jacks Blending Hammer
XL JXHMR
\$169.95



- Balanced accurately blending hammer
- Similar weight as the JXHMR
- 17.75" length
- Comes with M24 Polished Tip (M24-PT) and B2 Plastic Tip (B2-P)

Titanium Blending Hammer
TIT HMR
\$169.95



- 3.5 oz.
- Titanium Head, Ashen Wood Handle
- 14" / 35.5 cm
- Wooden Carrying Box

VIP Knockdown 1.5
VIP KD
\$40.00



- Aluminum Core
- High Carbon polished heat-treated steel tip
- Rubber Cushion Grip
- Precise Taper for Fine Detailing Finishes
- Great for Aluminum and Steel Finishes

VIP Knockdown 2.0
VIP 2.0
\$52.00



- Hex Head to Keep from Rolling on Aluminum Panels
- Magnet to Stick to Steel Panels
- Heat Treated Polished Stainless Steel Tip
- Thick, Soft Rubber Cushion
- Precise Taper for Fine Detailing Finish

VIP Knockdown 3.0





VIP 3.0
(No Tips)
\$63.00

VIP 3.0
(With Tips)
\$145.00

- Aluminum Anodized
- Built in Magnet
- Hex Head
- Comes with 3 Tips (As Shown)
- Works with Dentcraft's Interchangeable Tips (p.25-26)

Accessories

With increasing manufacturer costs, prices for accessories may change without notice. Please call, or visit website for most up-to-date pricing.

<p>Serrated Glue Cutter SGKLR \$49.95</p>  <p>20" 25" OAL</p>	<p>Mini Serrated Glue Cutter MSGC \$39.95</p>  <p>12-1/2" 17" OAL</p>
VERY SHARP!	

Door Strap
DRSTP
\$9.95



(Strap, S-Hook, Plastic Knockdown)

Combo Strap
CBSTP
\$74.95



- 4-1/2" Suction Cup
- 1-1/2" Wide HD Strap with Hook
- 5 Door Stop Lengths
- 5 Suction Cup Eyelets
- Large Side Entry Hoop
- Plastic Knockdown

Spatulas

	16180	\$27.95	10" Offset
	17473	\$34.95	14" Straight



Dent Mirror Estimate Shade
Dent Mirror
\$64.95

- Large Folding Estimation Shade
- See Dents Easier and Quicker
- Carrying Case Folds Down to 12" / 30.4 cm
- Expands to a Diameter of 31" / 78.8 cm
- Easily Covers Full Panels in a Few Swipes

(Great for Field Appraisers and Insurance Adjusters!)

Tesa Dent Tape



Tesa Tape
\$12.95

- Tesa Tape 51006
- Can be used to wrap pushing tip, knockdowns, knockdown hammer

Accessories

****With increasing manufacturer costs, prices for accessories may change without notice. Please call, or visit website for most up-to-date pricing.****

Adjustable Hanging Leverage Bar

BAR143
\$129.95



- 17" (43cm) overall width, 13" (33cm) inside of strap useable width
- 15 x Rod Grooves, Reversible for use with no grooves
- 7 x 1" adjustments via grommets
- 7 x 1" adjustments via top bar loops
- 1 x 17", 5/8" diameter 1 pc. Delrin Top - for one handed use

Rope Ratchets



Rope 14 **\$9.95** 1/4"



Rope 18 **\$5.95** 1/8"

Rod Leverage Tool Fulcrum Stick

\$27.95



**Fulcrum
Ring**
\$5.95

- 1 x M96-R
- 2 x E3 (2" Extensions)
- 1 x Fulcrum Ring (Threaded Ring)

(Add or Subtract Extensions for Longer or Shorter Lengths)

Large Suction Cup

LGSUC
\$55.95



3" x 6"

2pc Fender Blowout Ropes

FNDRP
\$44.95



1. Remove wheel lining
2. Attach soft end to the fender
3. Attach hook to a tie-off point
4. Tension rope ratchet

Attaches to the edge of a panel, to prevent panel from pulling away from the vehicle while repairing a dent.

Moose Knuckle Tire Leverage Accessory

M KNUCKLE
\$149.00

(Includes Strap)



Sits on top of tire to create an adjustable fulcrum for a PDR Rod.

Plugs and Retainers

With increasing manufacturer costs, prices for accessories may change without notice. Please call, or visit website for most up-to-date pricing.



Multi Plug Kit MULTI \$89.95

Locking Plugs

LP3/16	100ct.
LP1/4	100ct.
LP5/16	100ct.
LP3/8	100ct.
LP1/2	100ct.
LP9/16	50ct.
LP5/8	50ct.
LP3/4	50ct.

FLUSH PLUGS

FP1/4	100ct.
FP3/8	100ct.
FP1/2	100ct.
FP3/4	50ct.

DEPRESSED PLUGS

DP3/8	100ct.
DP1/2	100ct.
DP3/4	50ct.

Hood Insulation Retainers

FHIR	20ct.
GMLIR	20ct.
GMSHIR	20ct.

(Includes over 1,300 Assorted Plugs)

Locking Plugs



Item	100ct.	500ct.	1000ct.
LP3/16	\$5.95	\$25.00	\$40.00
LP1/4	\$5.95	\$25.00	\$40.00
LP5/16	\$5.95	\$25.00	\$40.00
LP3/8	\$5.95	\$25.00	\$40.00
LP1/2	\$5.95	\$25.00	\$40.00
LP9/16	\$6.95	\$30.00	\$50.00
LP5/8	\$6.95	\$30.00	\$50.00
LP3/4	\$7.95	\$35.00	\$60.00

Depressed Plugs



Item	100ct.	500ct.	1000ct.
DP3/8	\$5.95	\$25.00	\$40.00
DP1/2	\$5.95	\$25.00	\$40.00
DP3/4	\$7.95	\$35.00	\$60.00

Hood Insulation Retainers

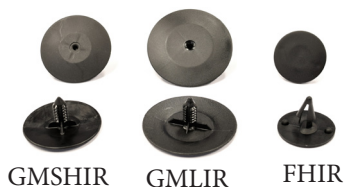

Item	Description	100ct.
GMSHIR	GM Small	\$20.00
GMLIR	GM Large	\$20.00
FHIR	Ford Hood	\$20.00

Flush Plugs



Item	100ct.	500ct.	1000ct.
FP1/4	\$5.95	\$25.00	\$40.00
FP3/8	\$5.95	\$25.00	\$40.00
FP1/2	\$5.95	\$25.00	\$40.00
FP3/4	\$7.95	\$35.00	\$60.00

Accessories

With increasing manufacturer costs, prices for accessories may change without notice. Please call, or visit website for most up-to-date pricing.

Buffer Pads
330G
\$11.95
(Includes 2 pads)



Adapter
BAD 1
\$24.95



Buffer Adapter Kit
BAKIT
\$44.95
(Kit includes: 330G, BAD 1, & 358BK)



Back Plate
358BK
\$10.95

This Kit allows you to turn your drill/driver into a small spot buffer with a 3" buffer pad, adapter, and backing plate.

Buff & Shine
3" Wool Pads
BS301G
\$13.95
(2 pack)



ToleCut



25 sheets
8 squares per sheet

TC Pink	\$39.95 (per pack)	1500 Grit
TC Green	\$39.95 (per pack)	2000 Grit
TC Black	\$39.95 (per pack)	3000 Grit
TC Pad	\$13.95 (2 pack)	



BCKPL	\$28.95	10" Schlegel Hook & Loop Backing Plate
BPAD	\$14.95	10" Buff & Shine Hook & Loop Wool Pad
05738	\$27.95	8" 3M Foam Polishing Pad
1551	\$9.95	6" Schlegel Drill Buffer Pad w/ 1/4" Shaft

Meguiars
Sanding Blocks



K1500	\$20.95	1500 Grit
K2000	\$20.95	2000 Grit



05921	\$34.95 (100pk)	3M 1500 Grit Discs
13441	\$5.95	3M Hand Sanding Pad

Posca Markers

PMRK



PMRK \$4.95

BMRK



BMRK \$4.95

Fluorescent Pink
Fluorescent Blue

Chalk based paint markers for marking dents when estimating repairs

Drill Bits

With increasing manufacturer costs, prices for accessories may change without notice. Please call, or visit website for most up-to-date pricing.

Magna Tree Bits



SDT6

44659

SDT3

Two Flute titanium coated tree bits that make smaller chips (less scratching) and improved wear.

- SDT6 \$27.95 1/2" 6 Step Tree Bit
(Starts at 3/16" and steps through only and all of the standard plug hole sizes up to and including 1/2".)
- 44659 \$27.95 1/2" Short Tree Bit
(This short bit is easy to start, making ideal for inside wheel wells.)
- SDT3 \$44.95 3/4" 9 Step Tree Bit
(Starts at 1/4" and steps up to and including 3/4".)

Rotabroach



- | | | |
|-------|---------|--------------------------------------|
| 11090 | \$84.95 | Rotabroach Kit 5/16" - 3/4" |
| 11080 | \$56.95 | PDR Access Kit 1/4", 3/8" 1/2", 3/4" |
| 11096 | \$52.95 | Rotabroach Kit 3/8" w/ Pilot |
| 11095 | \$49.95 | Rotabroach Kit 1/2" |
| 11122 | \$16.95 | Arbor 3/8" Chuck |
| 11121 | \$7.95 | Pilots for 11122 |
| 11123 | \$21.95 | Arbor 3/8" Pilot |
| 11034 | \$1.95 | Ejector Spring for 11122 & 11123 |
| 11055 | \$1.95 | Stop Washer for 11122 & 11123 |
| 11097 | \$16.95 | Pilots for 11123 |
| 11132 | \$45.95 | 3/4" Rotabroach Cutter (3pk) |
| 11116 | \$34.95 | 1/2" Rotabroach Cutter (3pk) |
| 11108 | \$27.95 | 3/8" Rotabroach Cutter (3pk) |
| 11100 | \$23.25 | 1/4" Rotabroach Cutter (3pk) |

Blair



- | | | |
|-------|---------|------------------------------|
| 13218 | \$54.95 | Blair Cutter Kit 1/4" - 5/8" |
| 13217 | \$7.95 | Blair Pilots (3pk) |
| 13216 | \$11.95 | Blair 1/4" Arbor |
| 11049 | \$0.55 | Ejector Spring for 13216 |
| 13212 | \$28.95 | 5/8" Blair Cutter (3pk) |
| 13208 | \$24.95 | 1/2" Blair Cutter (3pk) |
| 13204 | \$16.95 | 3/8" Blair Cutter (3pk) |
| 13202 | \$14.95 | 5/16" Blair Cutter (3pk) |
| 13200 | \$12.95 | 1/4" Blair Cutter (3pk) |

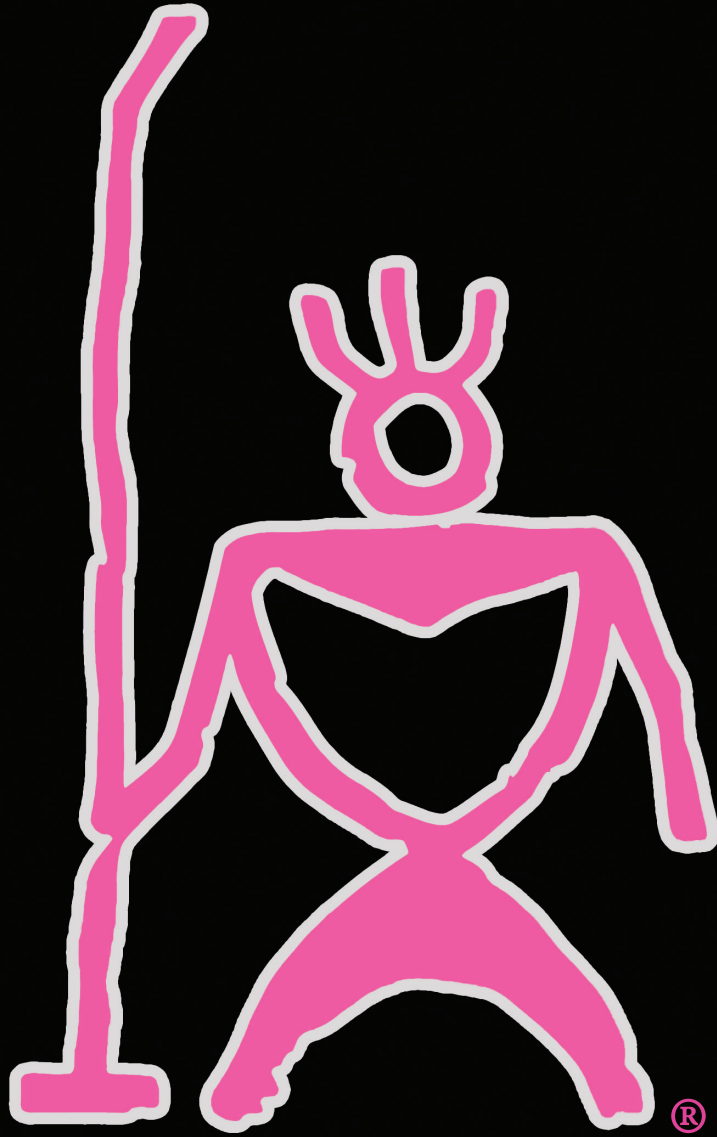

www.Dentcraft.com

ADDRESS

Dentcraft Tools
8118 Glade Avenue
Oklahoma City, OK 73132

Phone

1-888-738-6657 - Toll Free
(405) 495-0533 - OKC

Business Hours

Mon. - Thurs. 8am - 5pm CT
Fri. 8am - 3pm CT

Email

info@dentcraft.com



100% Money Back Guarantee!
LIFETIME WARRANTY

Try them for 60 days. If you are not 100% satisfied with any tool, just return it for a full refund.

Dentcraft Tools, L.P. provides a lifetime guarantee against breakage on any steel tool we make 3/16" diameter or larger. A 3-year guarantee on collapsible rod set. A one-year guarantee on whale tails and any tool smaller than 3/16" diameter. Any tools returned for any other reason must be returned within 60 days of purchase to receive a full refund.